



Description		Part No.	Quantity
Heat Exchanger 'O' Ring	Standard for all engines to 2019	209-00814	2
	3rd 'O' Ring for 2019 Spec. Manifold Only	209-11054	1
	Triple 'O' Ring Kit for 2019 Spec. Only	209-21737	1
Tube Adaptor	For 3rd 'O' Ring for 2019 Spec. Only	201-10963	1
Sacrificial Zinc Anode		209-61840	1
Exhaust Gasket	4 Bolt	600-98960	1
	6 Bolt for 2019 Non-Turbo 2019 Spec. Manifold	212-20438	
Pressure Cap		209-80130	1
60mm Water Injection Bend	From October 2002	202-02951	1
Thermostat	From October 2004	600-07489	1
	To September 2004	600-00581	
Thermostat Gasket	From October 2004	600-04360	1
	To September 2004	600-00582	
Drive Plate	SAE10 - PRM260	206-97010	1
	SAE10 - PRM500	206-04295	
	SAE10 - ZF25/BW71C	206-00090	
Standard Kubota alternator	Alternator	600-00632	1
	V Belt - Check Before Ordering	214-94260	1
	6PK PolyVee Drive Belt - Check Before Ordering	214-01470/01	1
Iskra 95 Amp alternator in lieu of standard	Alternator	200-01167	1
	6PK PolyVee Drive Belt - Check Before Ordering	214-02142	1
70 Amp insulated return alternator in lieu of standard	Alternator	200-01384	1
	V Belt - Check Before Ordering	214-99226	1
	6PK PolyVee Drive Belt - Check Before Ordering	214-02614	1
120 Amp alternator in lieu of standard	Alternator	200-08183	1
	6PK PolyVee Drive Belt - Check Before Ordering	214-92100	1
175 Amp alternator in lieu of standard	Alternator	200-05261	1
	6PK PolyVee Drive Belt - Check Before Ordering	214-92100	1
175 Amp alternator - 2nd domestic - Heat Exchanger Cooled	Alternator	200-05261	1
	6PK PolyVee Drive Belt - Check Before Ordering	214-92105	1
175 Amp alternator - 2nd domestic - Keel Cooled	Alternator	200-05261	1
	6PK PolyVee Drive Belt - Check Before Ordering	214-03226	1
Fuel Filter (Kubota Plunger Type)	To 2008 (Approx. 115mm OAL)	211-02817	1
	From 2008 (Approx. 70mm OAL)	211-60210	
	Beta 90 - From October 2009 (Approx. 115mm OAL)	211-02817	
Oil Filter Element		211-70510/02	1
Air Cleaner Element	From September 2009	211-03819	1
	To August 2009	211-04109	
	To January 2004	211-96980	
Sump Drain Pump		210-80061	1
Sump Drain Pump Clamp		212-00793	2
Beta Marine Gear Driven Sea Water Pump - From November 2013	Pump	207-01178/01	1
	Impeller Kit	207-10709	1
	Cover Plate 'O' Ring	207-10159	1
	End Cover Plate Screw	207-09483	5

## Quick Reference Tables

Description		Part No.	Quantity
Jabsco Gear Driven Sea Water Pump - To October 2013	Pump	207-01178	1
	Impeller Kit	207-10709	1
	Gasket	207-01101	1
	End Cover Plate	207-01102	1
	End Cover Plate Screw	207-01103	6
	Service Kit	207-01104	1
Johnson Belt Driven Sea Water Pump	Pump	207-97104	1
	Impeller Kit	207-02132-KIT	1
	Impeller 'O' Ring (Part of 207-02132-KIT)	207-10052	1
	Drive Belt	214-00182	1
	Driven Pulley	212-97105	1
	Service Kit (Inc. Mechanical Seal)	207-05268	1
	Rebuild Kit (No Impeller)	207-08602	1
Heat Exchanger Tubestack	Standard to 2019	209-02846	1
	2019 Spec. Manifold Only	209-10964	
Fuel Lift Pump		600-01466	1
Fuel Lift Pump Gasket		600-00065	1
Fuel Stop Solenoid	Energised to Stop - From October 2009	200-94370	1
	Energised to Run - From 2008	600-00627	
	Energised to Stop - To 2008	200-94370	
Control Panel Standard Key	From June 2008	600-00058/01	A pair
	To June 2008	600-00058	
Control Panel Key Switch	From June 2008	600-00057/01	1
	To June 2008	600-00057	
Control Panel Stop Button	Also ABVW, BW & CW Panel Heat & Start	200-00072	1
Tachometer	0-3000 rpm with Digital Hour Counter	200-21241	1
Water Temperature Gauge	For B, BW, C Deluxe & CW Control Panels	200-96200	1
Oil Pressure Gauge	For C Deluxe & CW Control Panels	200-96190	1
Voltmeter	For C Deluxe & CW Control Panels	200-96210	1
Green Power On Indicator	Lamp & Retaining Clip (P/N 200-09797)	200-04656	1
Red Warning Indicator	Lamp & Retaining Clip (P/N 200-09797)	200-04657	3 or 4
Alarm Board	ALL Panels - From June 2005	200-04655	1
Relay 12 Volt 40A (28Ra)	Fitted to the Rear of Panels	200-87020	1
40 Amp Fuse Blade		200-00959	1
Standard Engine Harness		200-08808	1
Water Temperature Switch	For A, ABV & ABVW Panels	600-62820	1
Water Temperature Sender	1/8" BSP For B, BW, C Deluxe & CW Control Panels - From April 2011	200-08248	
Water Temperature Sender	5/8" UNF For B, BW, C Deluxe & CW Control Panels - To April 2011	200-94360	
Water Temperature Switch	For Insulated Earth Return Engines & Panels	200-08830	
Oil Pressure Switch	For A, ABV, ABVW, B & BW Panels	600-62670	1
Oil Pressure Sender	For C Deluxe & CW Control Panels	200-94350	
Oil Pressure Switch	For Insulated Earth Return Engines & Panels	200-61190	

Description		Part No.	Quantity
Panel A - Key Switch		AK/2AS/KS01	1
Panel AB - Key Switch	0-3000 rpm Tachometer with Digital Hour Counter	AK/2ABD/KS031	
Panel ABV - Key Switch	0-3000 rpm Tachometer with Digital Hour Counter	AK/2ABV/KSOL301	
Panel ABVW - Push Button	0-3000 rpm Tachometer with Digital Hour Counter	AK/2ABVW/KS031	
Panel B - Key Switch	0-3000 rpm Tachometer with Digital Hour Counter & Temperature Gauge	AK/2BT/KS031	
Panel BW - Push Button	0-3000 rpm Tachometer with Digital Hour Counter & Temperature Gauge	AK/2BTW/KS031	
Panel C - Key Switch	0-3000 rpm Tachometer with Digital Hour Counter, Temperature, Oil Pressure & Voltage Gauges	AK/2CD/KSOL31	
Panel CW - Push Button	0-3000 rpm Tachometer with Digital Hour Counter, Temperature, Oil Pressure & Voltage Gauges	AK/2CW/KSOL31	
NMEA 2000 Module	Allows C & CW Panels to Interface with a NMEA 2000 Network	AK/P/2D/i01	
D-Digital - Push Button	Fully Digital Stand Alone or Fully NMEA 2000 Network Compatible Panel	AK/P/2D/KS01	
Cylinder Head Gasket	Beta 75 (BV3300)	600-00253	1
	Beta 75 (BV3600)	600-07636	
	Beta 90	600-08184	
Exhaust Manifold Gasket	Engine to Header Tank	600-00269	1
Top Gasket Set	Beta 75 (BV3300)	600-01099	1
Lower Gasket Set	Beta 75 (BV3300)	600-01100	1
Inlet Manifold Gasket	Beta 75 & Beta 90	600-00268	1
Flexible Mounts	Large 55 Shore Metalastic Type	213-96970/01	4
	Large 65 Shore Metalastic Type	213-02646/02	
Extended Dipstick Kit	Guide & Stick - Will Require Shaping to Fit	600-96330	1
Rocker Cover Gasket		600-00257	1

Manuals		Part No.	Quantity
Operators Maintenance Manual		221-20031	1
Workshop Manual – Base Engine Only	Beta 75 (BV3300)	600-00759	2 available as a PDF
	Beta 90 (BV3800)	600-07082	
Spare Parts Manual – Base Engine Only	Beta 75 (BV3300)	600-00228	2 available as a PDF
	Beta 90 (BV3800)	600-07083	

**Note:** the above part numbers are suitable for earth return installations only (where the battery negative cable is connected directly to engine earth/ground). For insulated earth (where battery negative cable is isolated from engine earth/ground) different harnesses, alternators, switches for oil pressure and engine temperature will be required.

If your application is wired as insulated earth return and the engine will not operate correctly, always check starter battery negative is connected to the correct terminal on the isolating solenoid. It should be connected to the terminal which is also used for all the small black wires, NOT the terminal with the single black wire connected directly to engine ground.

## Fuel Filter Identification

Any engine equipped with a square fuel filter assembly with priming button requires a fuel filter with the part number:

**211-60210**

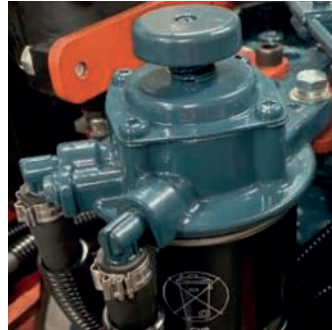

Any engine equipped with a round fuel filter assembly with priming button requires a fuel filter with the part number:

**211-02817**



## Heat Exchanger Cooled

IPL Beta 75 & Beta 90 (Non-Turbo) - Port View

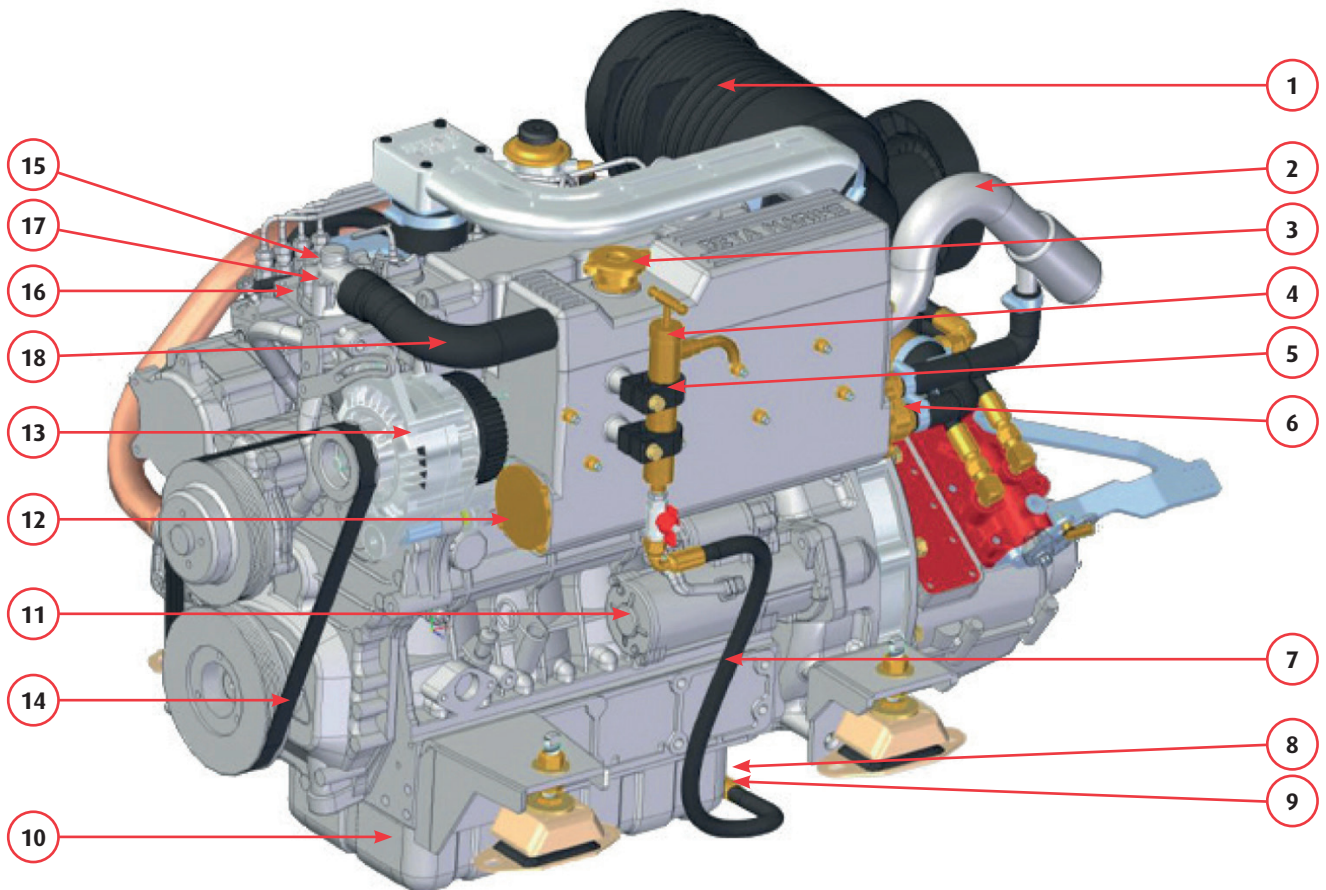

Ref.	Part No.	Description	Qty	Comments
1	211-03245	Air filter body	1	Including element, no top hat
2	202-02951	High rise water injection bend	1	
3	209-80130	Pressure cap	1	
4	210-80061	Sump drain pump	1	
5	212-00793	Clamp	1	
6	209-61840	Wasting zinc anode	1	
7	210-04362	Sump hose	1	
8	210-90940	Sump plug elbow	1	
9	201-02318	Tapped sump plug	1	
10	600-08044	Sump	1	
11	600-02184	Starter motor	1	Beta 75 (BV3300)
	600-06777			Beta 90 (BV3800)
12	209-00814	'O' ring	1	
13	600-00632	65 Amp alternator	1	Standard
	200-01167	95 Amp alternator		Optional
14	214-94260	65 Amp alternator V belt	1	
	214-02142	95 Amp alternator 6PK polyvee belt		
15	600-04892	Thermostat cover	1	
16	600-07489	Thermostat	1	From October 2002
17	600-00582	Thermostat gasket	1	From October 2002
18	218-00084	Water pipe elbow	1	

## Beta 75 & Beta 90 (Non-Turbo) - Starboard View

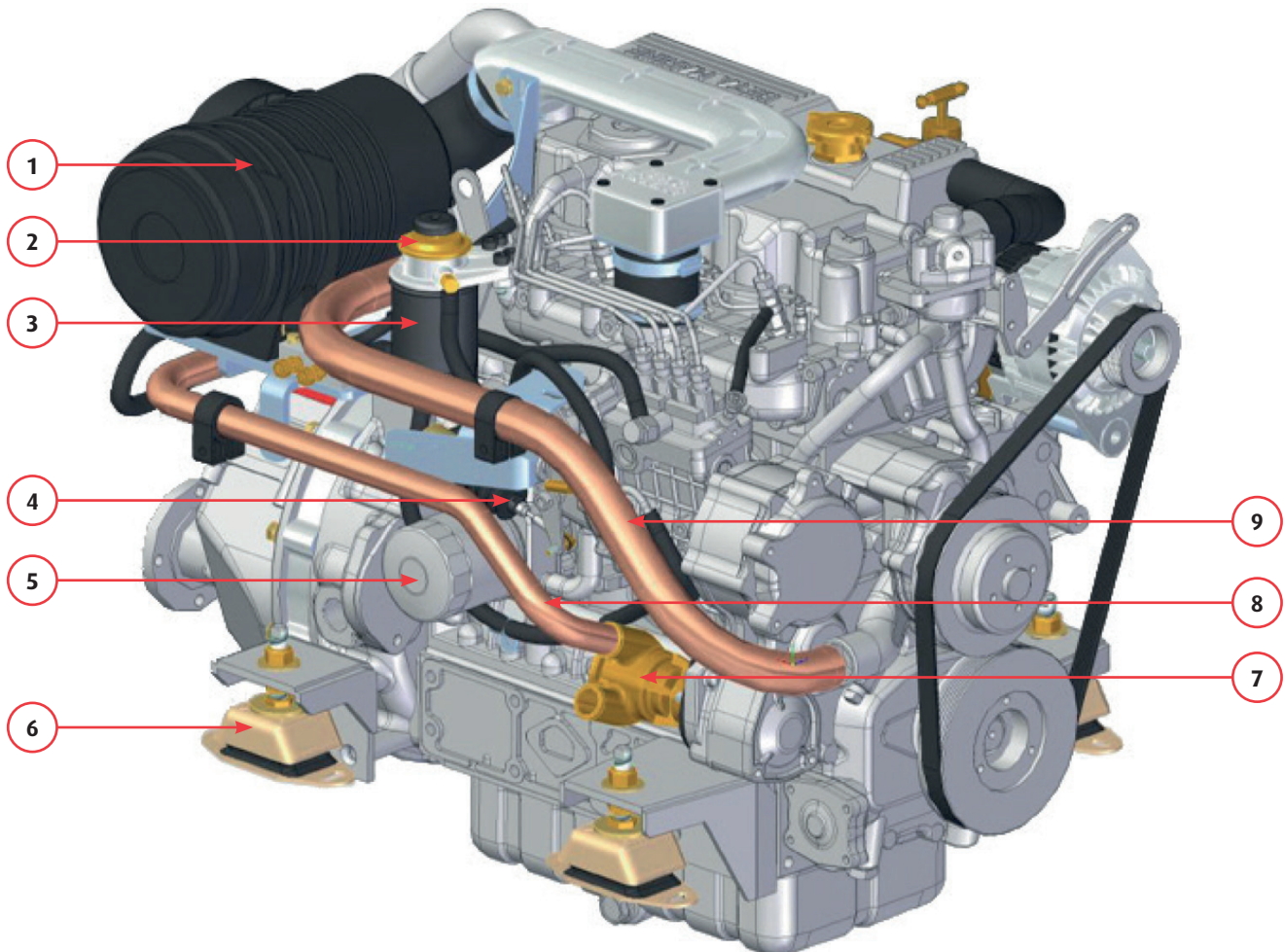

Ref.	Part No.	Description	Qty	Comments
1	211-03819	Air filter element	1	From September 2009
	211-04109			To August 2009
	211-96980			To January 2004
2	600-08990	Fuel filter head	1	Beta 90 (BV3800)
3	211-02817	Fuel filter	1	Beta 90 - From October 2009
	211-60210			From 2008
	211-02817			To 2008
4	200-94370	Fuel stop solenoid	1	From October 2009
	600-00627			From 2008
	200-94370			To 2008
5	211-70510/02	Oil filter	1	
6	213-96970/01	55 shore flexible mount	4	
	213-02646/02	65 shore flexible mount		
7	207-01178/01	Sea water pump (Impeller 207-10709)	1	From October 2013
	207-01178			To October 2013
8	202-08734	Sea water pipe	1	
9	202-06493	Fresh water pipe	1	

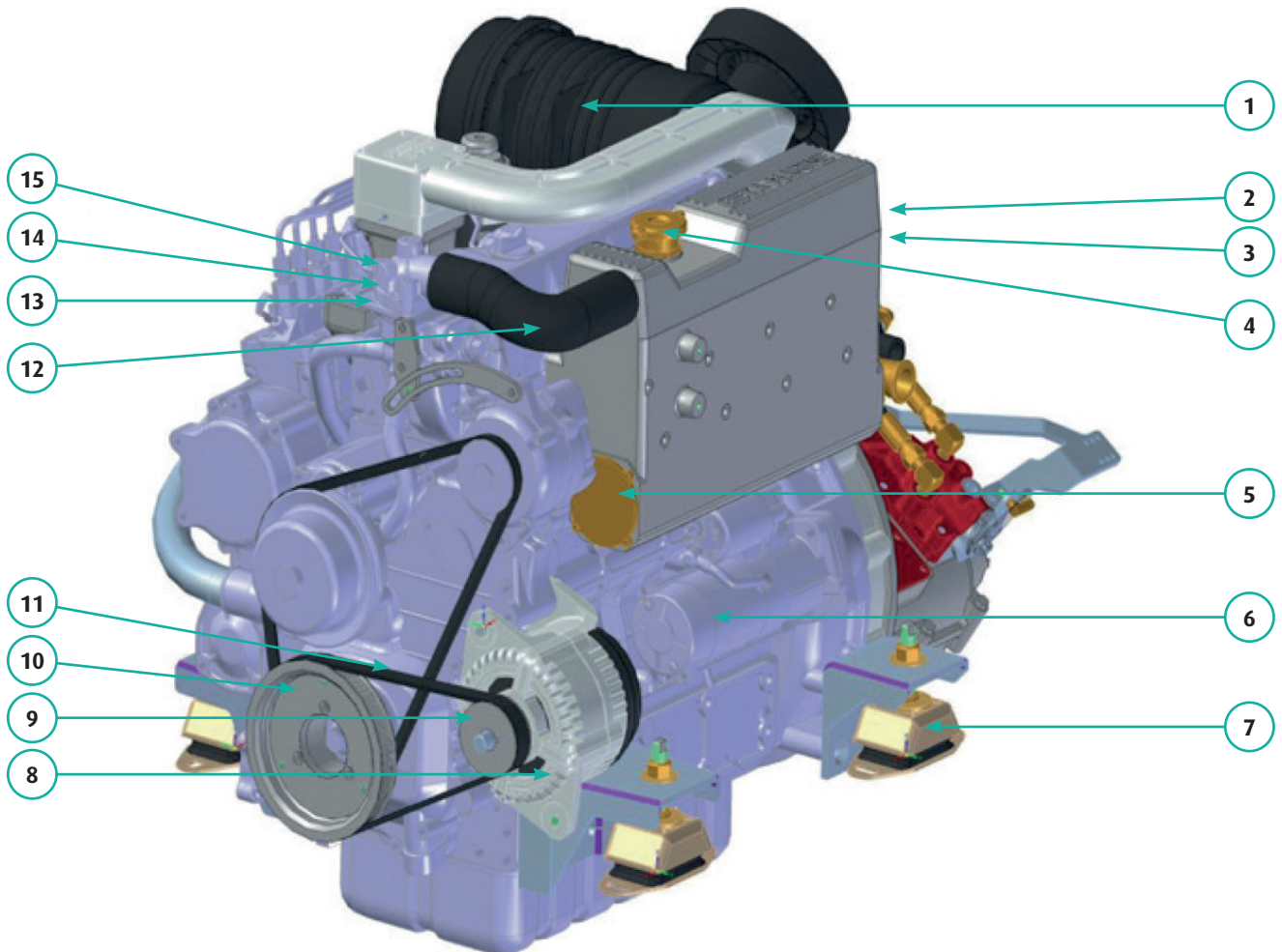

Ref.	Part No.	Description	Qty	Comments
1	211-03245	Air filter body	1	Including element, no top hat
2	600-00269	Exhaust manifold gasket	1	
3	600-98960	Exhaust elbow gasket	1	
4	209-80130	Pressure cap	1	
5	209-00814	'O' ring	1	
6	600-02184 600-06777	Starter motor	1	Beta 75 (BV3300) Beta 90 (BV3800)
7	213-96970/01 213-02646/02	55 shore flexible mount 65 shore flexible mount	4	
8	200-21897 200-05261	175 Amp alternator	1	From 2021 To 2021
9	201-04710	75mm diameter pulley	1	
10	201-01168	2nd Alternator drive pulley	1	
11	214-03226 214-05338	175 Amp alternator 6PK polyvee belt	1	From September 2011 To September 2011
12	218-00084	Water pipe elbow	1	
13	600-04892	Thermostat cover	1	
14	600-07489	Thermostat	1	From October 2002
15	600-00582	Thermostat gasket	1	From October 2002



## Beta 75 & Beta 90 (Non-Turbo) - Starboard View

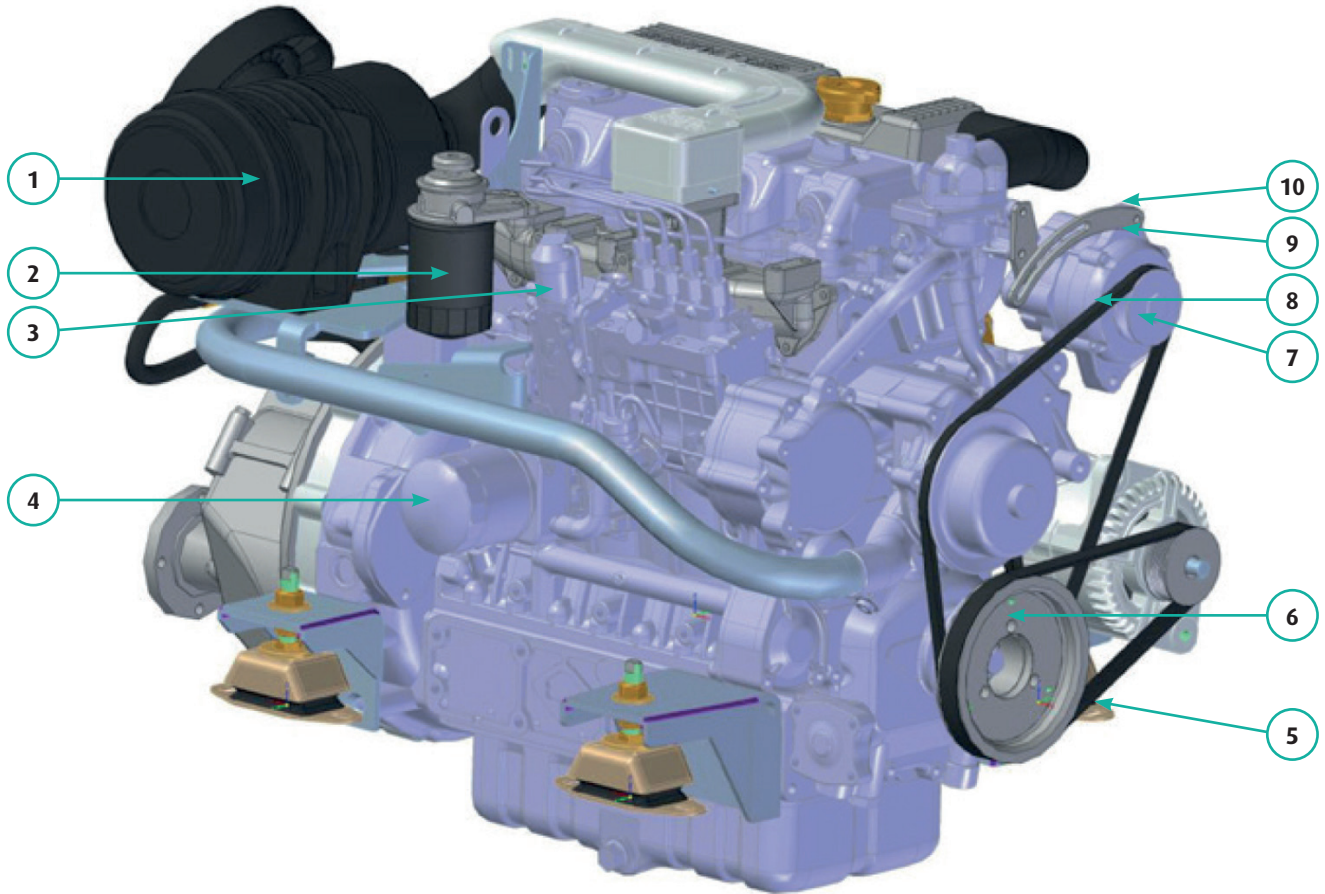

Ref.	Part No.	Description	Qty	Comments
1	211-03819	Air filter element	1	From September 2009
	211-04109			To August 2009
	211-96980			To January 2004
2	211-02817	Fuel filter	1	Beta 90 - From October 2009
	211-60210			From 2008
	211-02817			To 2008
3	200-94370	Fuel stop solenoid	1	From October 2009
	600-00627			From 2008
	200-94370			To 2008
4	211-70510/02	Oil filter	1	
5	AK/36000/175A/B01	2nd Alternator tensioner bracketry	1	
6	201-10580	2nd Alternator pulley	1	Requires 3 x socket cap screws 217-99312
7	600-00632	65 Amp alternator	1	Standard
8	214-94260	65 Amp alternator V belt	1	
9	600-10625	Alternator spacer	1	
10	217-02204	Bolt	1	Nut/spring and washer size M10

## Heat Exchanger Cooled

### IPL Beta 75 & Beta 90 (Non-Turbo) - Back View

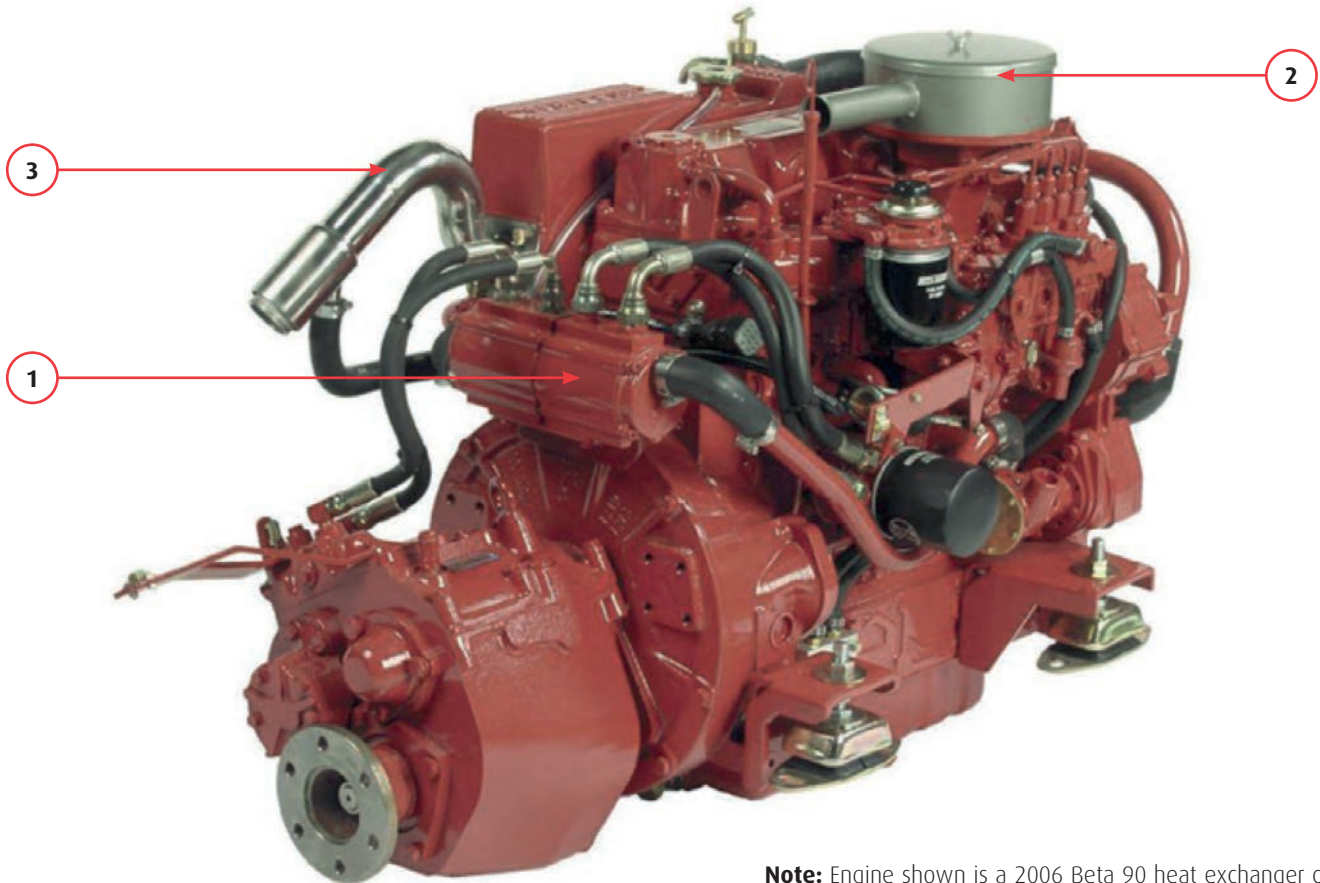

**Note:** Engine shown is a 2006 Beta 90 heat exchanger cooled

Ref.	Part No.	Description	Qty	Comments
1	210-80580	2 in 1 oil cooler	1	To April 2009, suits 'O' ring 209-02006
	210-82931	Oil cooler	1	From May 2007
2	202-05791	Air filter assembly	1	To August 2009, suits element 211-04109
3	202-02951	High rise water injection bend	1	

Gearbox Option	Gearbox Part No.	Drive Plate Part No.	Morse Gear Bracket Part No.	Adaptor Plate Part No.	Flexible Coupling Part No.
TM345 R2	204-06130	206-00090	202-08721	205-00133	212-01248
TM345A R2	204-03053				
TM93 R2	204-07342				
TM93A R2	204-08547				
PRM280 D2	204-10398	206-97010	202-80560	205-80540	212-02699
PRM280 D3	204-10436				
PRM500 D2	254-94830	206-04295	202-80560	205-97020	212-02699
PRM500 D2.5	254-94834				
PRM500 D3	254-94832				
ZF25H R2	204-98890	206-00090	202-05406	205-00133 & 205-85810	212-02409
ZF25HA R2	204-00743				
ZF45H R2	204-02360/02			205-04910 & 205-85810	212-02699
ZF63IV R2	204-07240			205-04911 & 205-85810	

This page is intentionally blank.

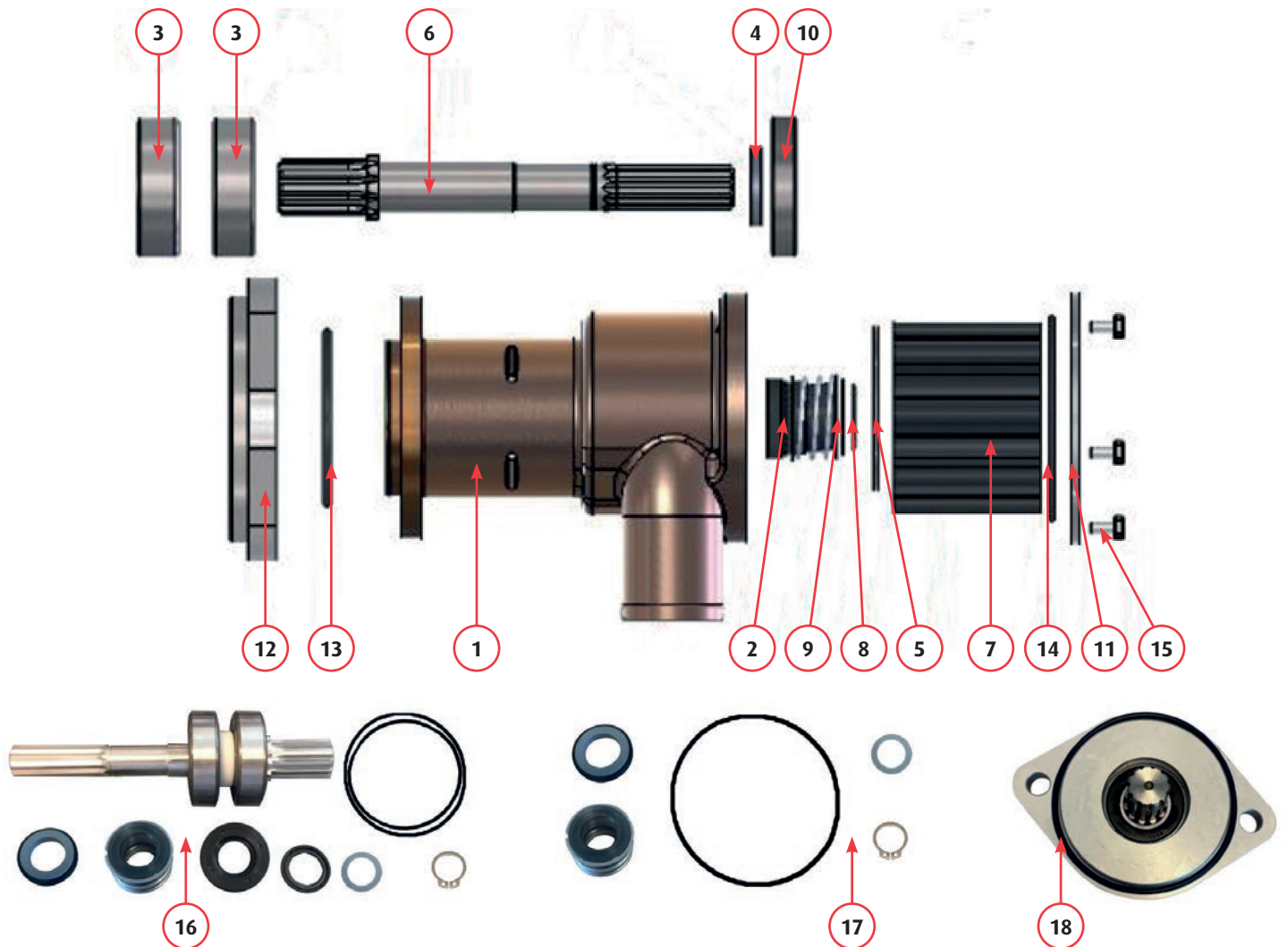

Ref.	Part No.	Description	Qty	Comments
1	207-01178/01	Sea water pump - complete	1	Includes silver front clamp - ref no 12
2	207-10505	Mechanical Seal 16mm	1	Also part of seal kit 207-10802
3	N/A	Sealed bearing	2	N/A - part of shaft kit 207-21458
4	N/A	Oil seal	1	N/A - part of shaft kit 207-21458
5	207-21032	Wear plate	1	
6	N/A	Shaft	1	N/A - part of shaft kit 207-21458
7	207-10709	Impeller	1	
8	N/A	External circlip	1	N/A - part of shaft kit 207-21458
9	N/A	Thrust washer	1	N/A - part of shaft kit 207-21458
10	N/A	Bearing spacer	1	N/A - part of shaft kit 207-21458
11	207-10799	Cover plate	1	
12	N/A	Front clamp	1	N/A - part of 207-01178/01
13	N/A	'O' ring, front clamp	1	N/A - part of 207-01178/01
14	207-10159	'O' ring, cover plate	1	Also part of shaft kit 207-21458
15	207-09483	End cover screw	5	
16	207-21458	Shaft kit to suit 207-01178/01 only	1	Includes 3, 4, 6, 8, 9 & 14
17	207-10802	Seal kit	1	Includes 2, 8, 9 & 14
18	600-00246	'O' ring, sea water pump to engine	1	

## Johnson 1" 12 Volt Clutched Pump

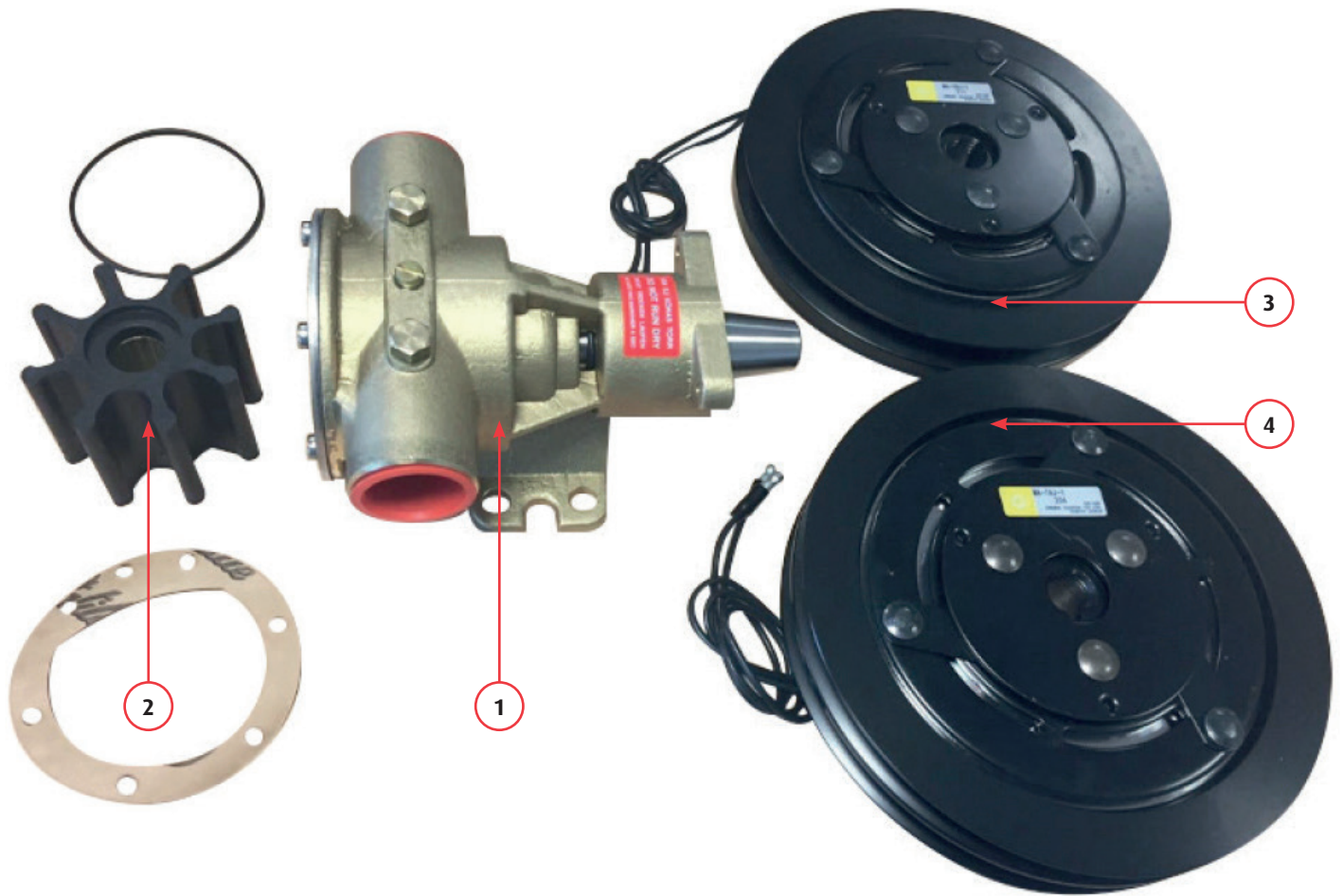

Ref.	Part No.	Description	Qty	Comments
1	207-07685	Sea water pump - complete	1	
2	207-10709	Impeller kit	1	
3	207-09856	Electro magnetic 12v clutch & 1 x SPB pulley	1	
4	207-07685/01	Electro magnetic 12v clutch & 2 x SPB pulley	1	

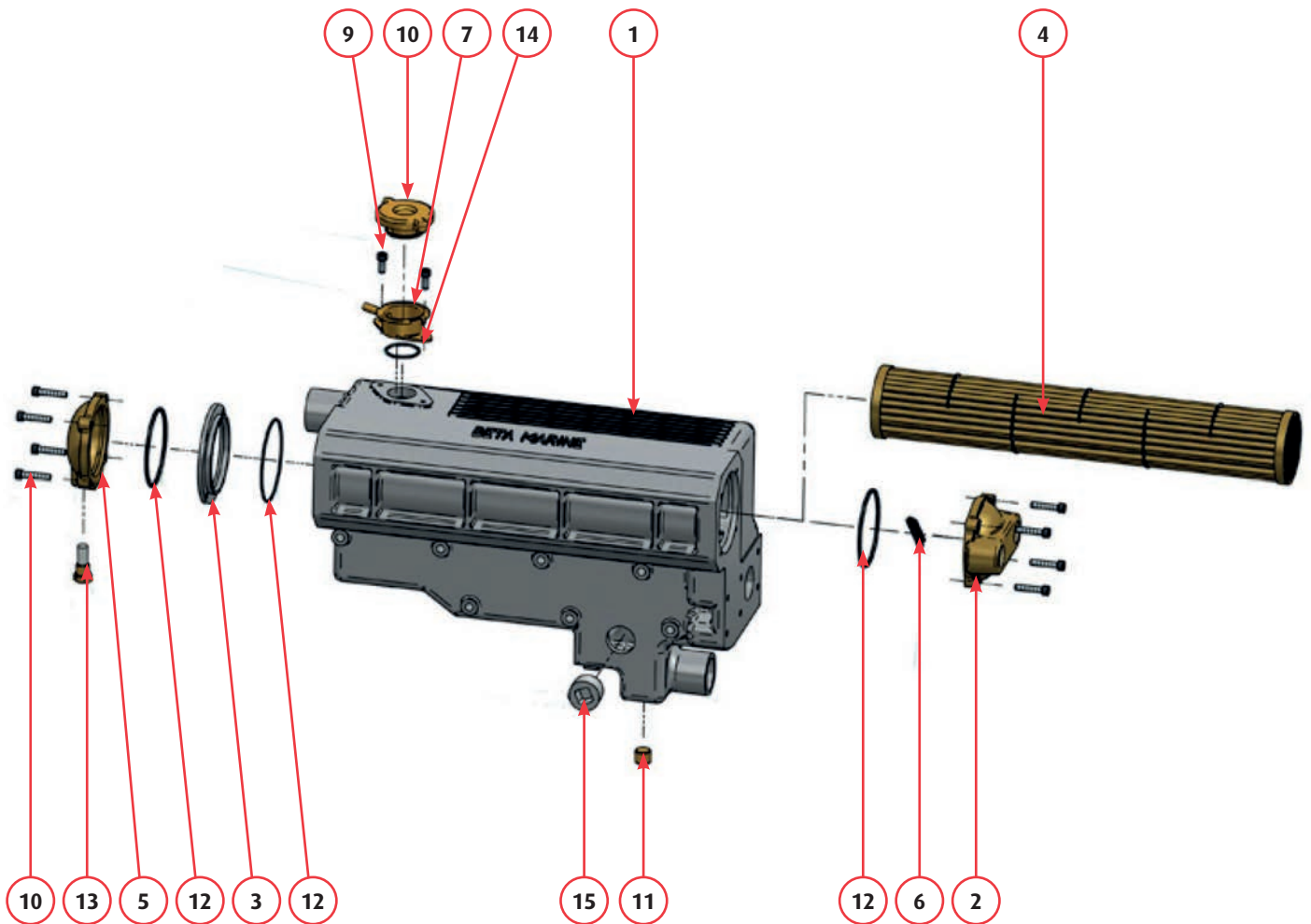

Ref.	Part No.	Description	Qty	Comments
1	208-10768-HE	Manifold tank	1	
2	208-10846	Heat exchanger end cap	1	
3	201-10963	Aluminium manifold spacer	1	
4	209-10964	Tube stack	1	
5	209-10965	Heat exchanger end cap	1	
6	209-03328	Rubber sealing strip	1	
7	209-08352	Tank filling neck	1	
8	209-80130	Pressure cap	1	
9	217-05033	M6 x16 cap head	2	
10	217-03974	M6 x30 socket cap head	8	
11	212-99403	3/8" BSP galvanized plug	1	
12	209-21737	'O' ring set	1	Set of 3
13	209-61840	Zinc anode	1	
14	209-02167/01	Filler neck 'O' ring	1	
15	212-00318	1" BSPT plug	1	

## Wiring Harness & Switches

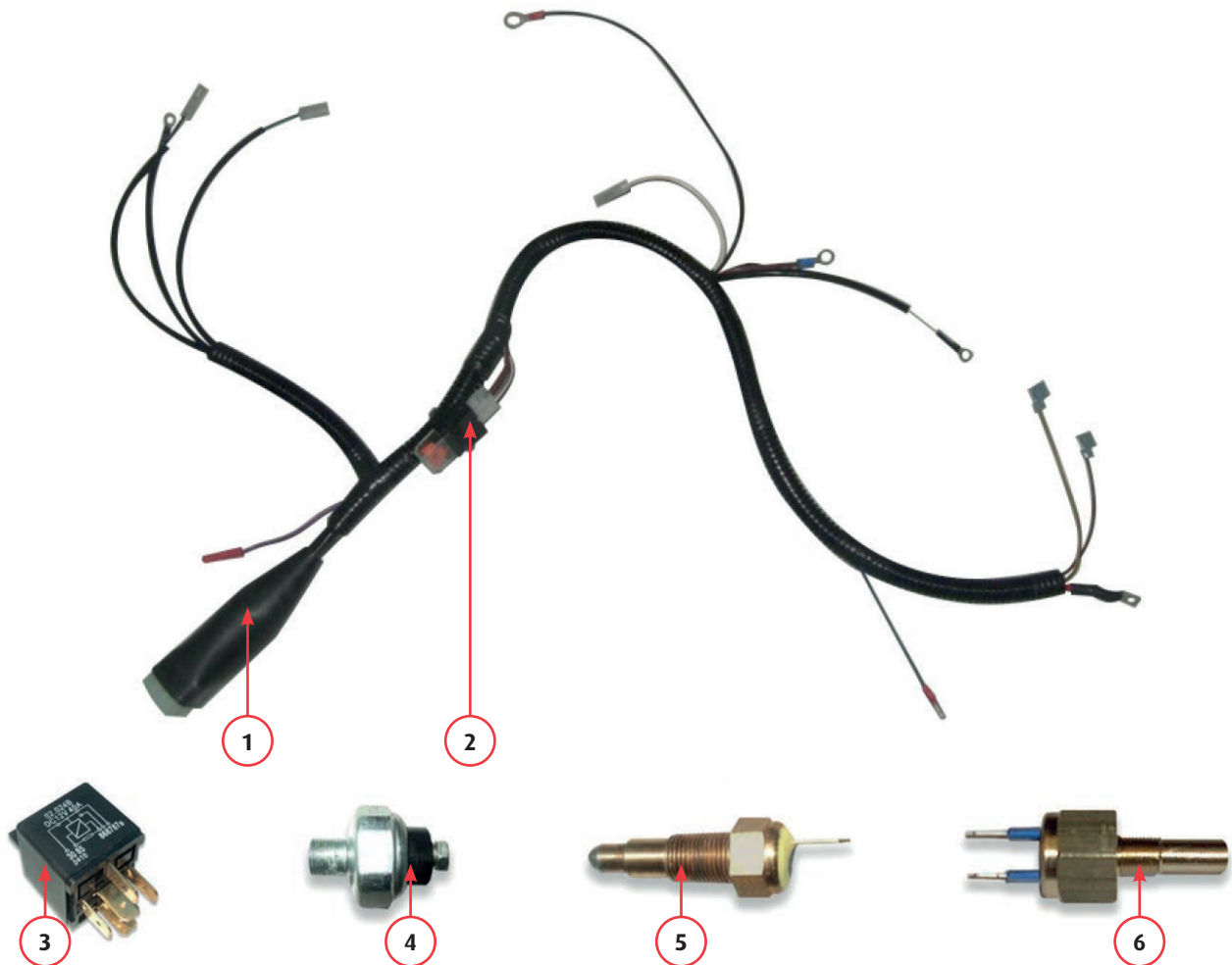

Ref.	Part No.	Description	Qty	Comments
1	200-08808	Beta 75 & 90 engine harness	1	Includes fuse & relay - From January 2010
2	200-00959	40 Amp fuse blade	1	
3	200-87020	Relay 12 Volt 40A (28Ra)	1	
4	600-62670	Oil pressure switch	1	Not C Deluxe & CW panel
5	600-62820	Water temperature switch	1	Not C Deluxe & CW panel
6	200-01133	Water temperature sender switch 95°C 1/8" BSP	1	Not C Deluxe & CW panel
7	212-01480	3/8" BSPT Male x 1/8" BSP Female galvanised adaptor for 200-01133	1	Required if temperature sender is being fitted into 3/8" BSP thread
8	200-04588/01	1 metre extension harness	1	Not shown
9	200-04588/02	2 metre extension harness	1	Not shown
10	200-04588/03	3 metre extension harness	1	Not shown
11	200-04588/04	4 metre extension harness	1	Not shown
12	200-04588/05	5 metre extension harness	1	Not shown
13	200-04588/06	6 metre extension harness	1	Not shown
14	200-04588/08	8 metre extension harness	1	Not shown
15	200-04588/10	10 metre extension harness	1	Not shown
16	200-04588/15	15 metre extension harness	1	Not shown
17	AK/P/7J3/12V3/R00	Relay kit (for extension harnesses)	1	Not shown
18	200-10792/B	Flybridge Y harness	1	Not shown, additionally requires ref no 17

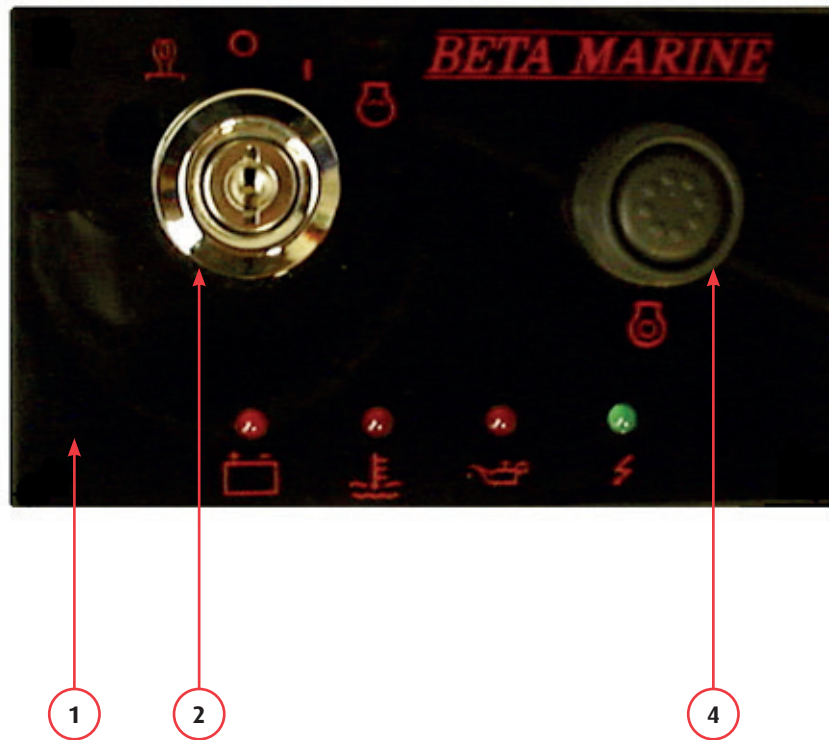

Ref.	Part No.	Description	Qty	Comments
1	N/A	Simple panel (complete with LED pack)	1	No Longer Available - use AK/2AS/KS01
2	600-00057	Kubota key switch - suits small key	1	To August 2008
3	600-00058	Kubota keys (small - pair)	1	To August 2008
4	200-00072	Panel stop button	1	
5	200-01295	LED Pack assembly & buzzer	1	SEASPEC Not shown
	200-01296	LED Pack assembly & buzzer		DOMESTIC Not shown
6	200-01288	A Panel LED type blank - suits 3 red & 1 green LED indicators	1	SEASPEC Facia only – check for availability
	200-01291	A Panel LED type blank - suits 4 red & 1 green LED indicators		DOMESTIC Facia only – check for availability
7	200-00639	11 Way plug to suit male type spade	1	Not shown, refer to page 35
8	200-00048	Large shroud for 11 way plug	1	Not shown, refer to page 35
9	200-00047	Male spade for 11 way plug	11	Not shown, refer to page 35



## A Panel – LAMP Type from May 2005



Ref.	Part No.	Description	Qty	Comments
1	AK/2AS/KS01	A panel with 3m loom	1	Complete
2	600-00057	Kubota key switch - suits small key	1	To August 2008
	600-00057/01	Kubota key switch - suits large key		From August 2008
3	600-00058	Kubota keys (small - pair)	1	To August 2008
	600-00058/01	Kubota keys (large - pair)		From August 2008
4	200-00072	Panel stop button	1	
5	200-04657	Red 12V warning lamp & retaining clip	3	
6	200-04656	Green 12V power on lamp & retaining clip	1	
7	N/A	A Panel LAMP type blank	1	Facia only – check for availability
8	200-00639	11 Way plug to suit male type spade	1	Not shown, refer to page 35
9	200-00048	Large shroud for 11 way plug	1	Not shown, refer to page 35
10	200-00047	Male spade for 11 way plug	11	Not shown, refer to page 35
11	200-04655	Alarm board with buzzer	1	Not shown, refer to page 35

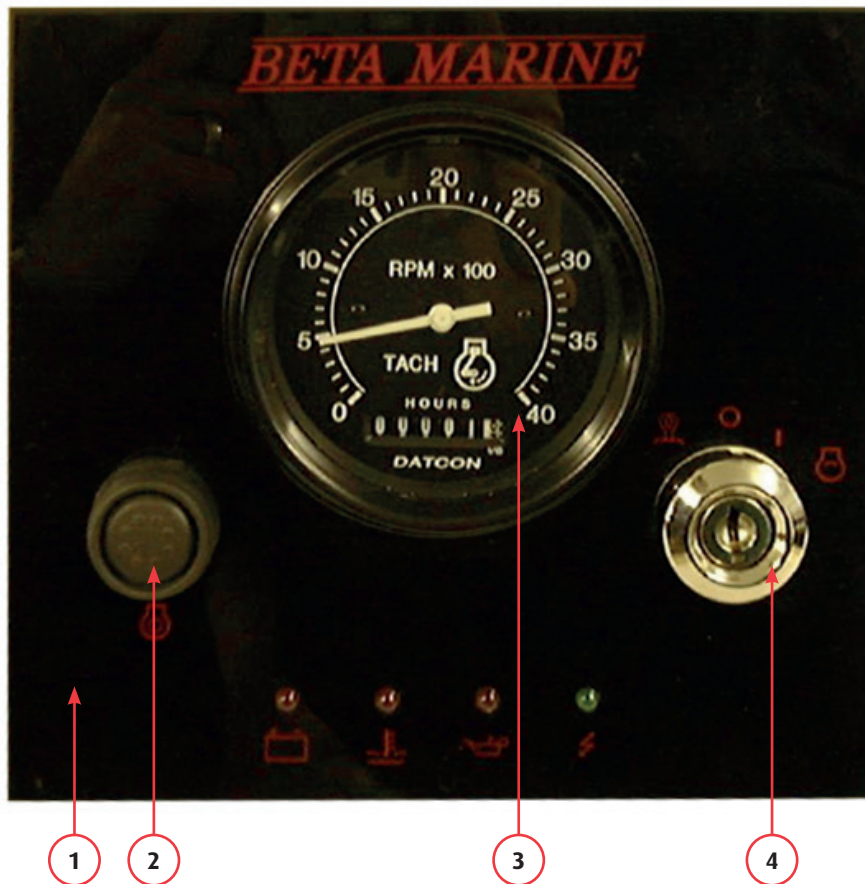

Ref.	Part No.	Description	Qty	Comments
1	200-00853	AB panel (excl. tachometer - ref no 3)	1	No Longer Available - use AK/2ABD/KSNT01
2	200-00072	Panel stop button	1	
3	200-02373/03	0-3000 rpm tachometer & hourmeter	1	VDO From March 2002 to May 2005 - No Longer Available
	200-00054	0-4000 rpm tachometer & hourmeter		DATCON To March 2002 - No Longer Available
4	600-00057	Kubota key switch - suits small key	1	To August 2008
5	600-00058	Kubota keys (small - pair)	1	Not shown, refer to page 35
6	200-01295	LED Pack assembly & buzzer	1	SEASPEC Not shown - check for availability
	200-01296	LED Pack assembly & buzzer		DOMESTIC Not shown - check for availability
7	200-01289	AB Panel blank	1	SEASPEC Facia only - check for availability
	200-01292	AB Panel blank		DOMESTIC Facia only - check for availability
8	200-00639	11 Way plug to suit male type spade	1	Not shown, refer to page 35
9	200-00048	Large shroud for 11 way plug	1	Not shown, refer to page 35
10	200-00047	Male spade for 11 way plug	11	Not shown, refer to page 35

## AB Panel – LAMP Type from May 2005

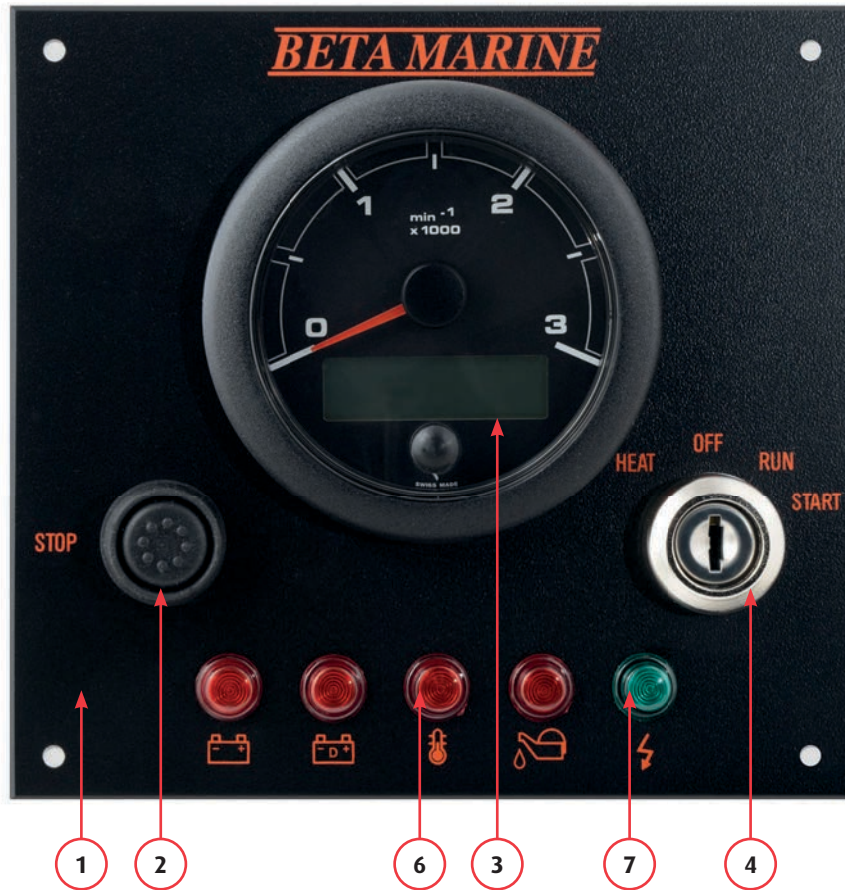

Ref.	Part No.	Description	Qty	Comments
1	AK/2ABD/KSO31	AB panel with 3m loom	1	Complete
	AK/2ABD/KSNT01	AB panel with 3m loom		No tachometer
2	200-00072	Panel stop button	1	
3	200-21241	0-3000 rpm tachometer with digital hour counter	1	OCEANLINK From November 2021
	200-02373/03	0-3000 rpm tachometer with digital hour counter		VIEWLINE From January 2010 to November 2021
	200-02373	0-4000 rpm tachometer with hourmeter		VDO From 2002 to January 2010 - No Longer Available
4	600-00057	Kubota key switch - suits small key	1	To August 2008
	600-00057/01	Kubota key switch - suits large key		From August 2008
5	600-00058	Kubota keys (small - pair)	1	To August 2008
	600-00058/01	Kubota keys (large - pair)		From August 2008
6	200-04657	Red 12V warning lamp & retaining clip	4	
7	200-04656	Green 12V power on lamp & retaining clip	1	
8	N/A	AB Panel blank	1	Facia only – check for availability
9	200-00639	11 Way plug to suit male type spade	1	Not shown, refer to page 35
10	200-00048	Large shroud for 11 way plug	1	Not shown, refer to page 35
11	200-00047	Male spade for 11 way plug	11	Not shown, refer to page 35
12	200-04655	Alarm board with buzzer	1	Not shown, refer to page 35
13	200-87020	12V 28Ra 40Amp relay	1	Not shown, refer to page 35

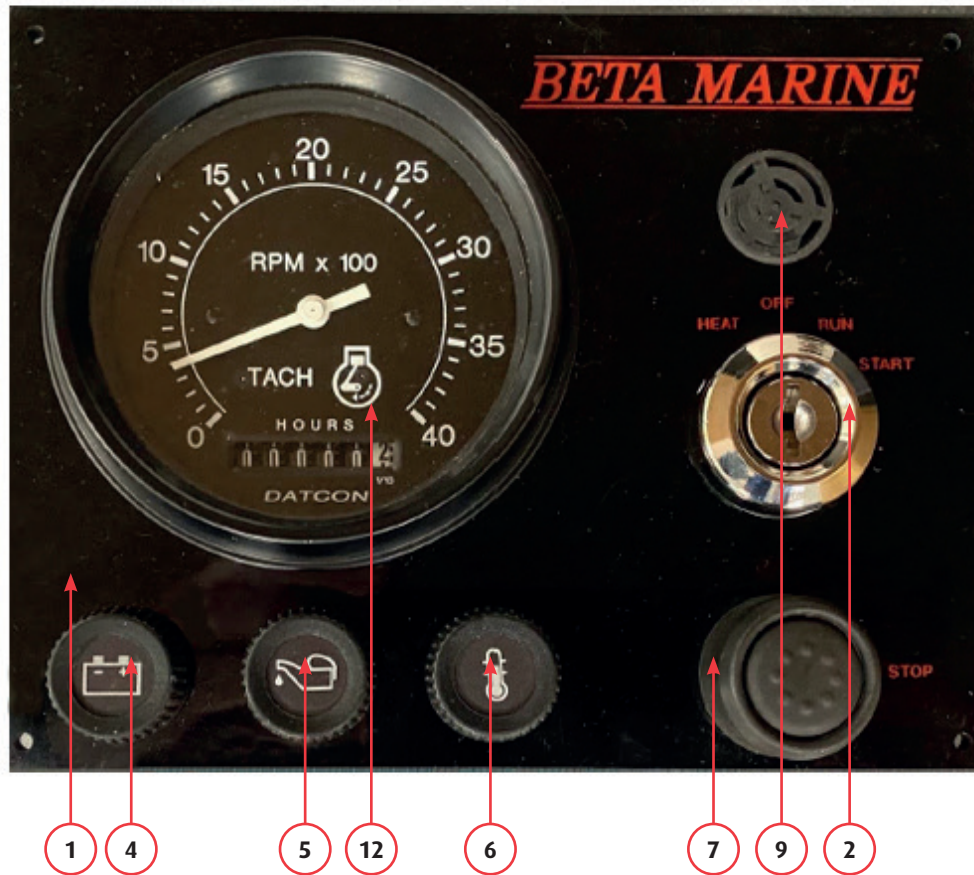

Ref.	Part No.	Description	Qty	Comments
1	200-89421	ABV panel (excl. tachometer - ref no 12)	1	No Longer Available - use AK/2ABV/KSNT01
2	600-00057	Kubota key switch - suits small key	1	
3	600-00058	Kubota keys (small - pair)	1	Not shown, refer to page 35
4	200-00059	Warning lamp battery	1	No Longer Available
5	200-00060	Warning lamp oil	1	No Longer Available
6	200-00061	Warning lamp water	1	No Longer Available
7	200-00072	Panel stop button	1	
8	200-97490	12V bulb	3	Not shown
9	200-99433	12V DC buzzer	1	
10	200-98980	Panel diode pack	1	Not shown, refer to page 35
11	200-00042	ABV Panel blank	1	Facia only – check for availability
12	200-02373/03	0-3000 rpm tachometer & hourmeter	1	VDO From 2002 to January 2010 - No Longer Available
	200-00054	0-4000 rpm tachometer & hourmeter		DATCON To March 2002 - No Longer Available
13	200-00639	11 Way plug to suit male type spade	1	Not shown, refer to page 35
14	200-00048	Large shroud for 11 way plug	1	Not shown, refer to page 35
15	200-00047	Male spade for 11 way plug	11	Not shown, refer to page 35

## ABV Panel – LAMP Type from May 2005



Ref.	Part No.	Description	Qty	Comments
1	AK/2ABV/KSOL301	ABV panel with 3m loom	1	Complete
	AK/2ABV/KSNT01	ABV panel with 3m loom		No tachometer
2	600-00057	Kubota key switch - suits small key	1	To July 2008
	600-00057/01	Kubota key switch - suits large key		From July 2008
3	600-00058	Kubota keys (small - pair)	1	To July 2008
	600-00058/01	Kubota keys (large - pair)		From July 2008
4	200-04657	Red 12V warning lamp & retaining clip	3	
5	200-04656	Green 12V power on lamp & retaining clip	1	
6	200-00072	Panel stop button	1	
7	200-21241	0-3000 rpm tachometer with digital hour counter	1	OCEANLINK From June 2021
	200-02373/03	0-3000 rpm tachometer with digital hour counter		VIEWLINE From January 2010 to June 2021
	200-02373/03	0-3000 rpm tachometer & hourmeter		VDO From 2002 to January 2010 - No Longer Available
8	N/A	ABV Panel blank	1	Facia only – check for availability
9	200-00639	11 Way plug to suit male type spade	1	Not shown, refer to page 35
10	200-00048	Large shroud for 11 way plug	1	Not shown, refer to page 35
11	200-00047	Male spade for 11 way plug	11	Not shown, refer to page 35
12	200-04655	Alarm board with buzzer	1	Not shown, refer to page 35
13	200-87020	12V 28Ra 40Amp relay	1	Not shown, refer to page 35



Ref.	Part No.	Description	Qty	Comments
1	AK/2ABVW/KSO31	ABVW panel with 3m loom	1	Complete
	AK/2ABVW/KSNT01	ABVW panel with 3m loom		No tachometer
2	200-00072	Panel stop/start/heat button	3	
3	200-04657	Red 12V warning lamp & retaining clip	3	
4	200-04656	Green 12V power on lamp & retaining clip	1	
5	200-21241	0-3000 rpm tachometer with digital hour counter	1	OCEANLINK From November 2021
	200-02373/03	0-3000 rpm tachometer with digital hour counter		VIEWLINE From January 2010 to November 2021
	200-02373/03	0-3000 rpm tachometer & hourmeter		VDO From 2002 to January 2010 - No Longer Available
6	N/A	ABVW Panel blank	1	Facia only – check for availability
7	200-00639	11 Way plug to suit male type spade	1	Not shown, refer to page 35
8	200-00048	Large shroud for 11 way plug	1	Not shown, refer to page 35
9	200-00047	Male spade for 11 way plug	11	Not shown, refer to page 35
10	200-04655	Alarm board with buzzer	1	Not shown, refer to page 35
11	200-87020	12V 28Ra 40Amp relay	2	Not shown, refer to page 35
12	200-03466	Pektron diode	1	Not shown, refer to page 35
13	200-02618	Diode bridge	1	Not shown, refer to page 35

## Service Kit to Suit ABVW Push Button Control Panels

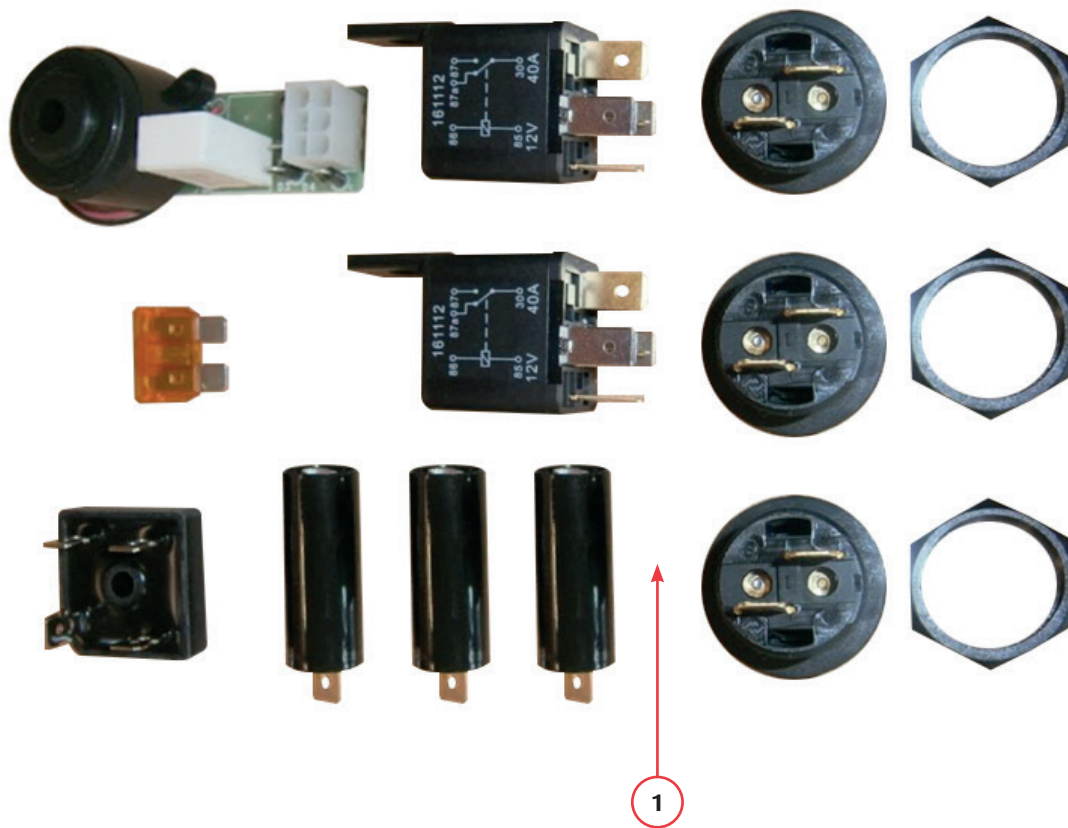

Ref.	Part No.	Description	Qty	Comments
1	AK/2ABVW/RKS01	ABVW panel service kit	1	

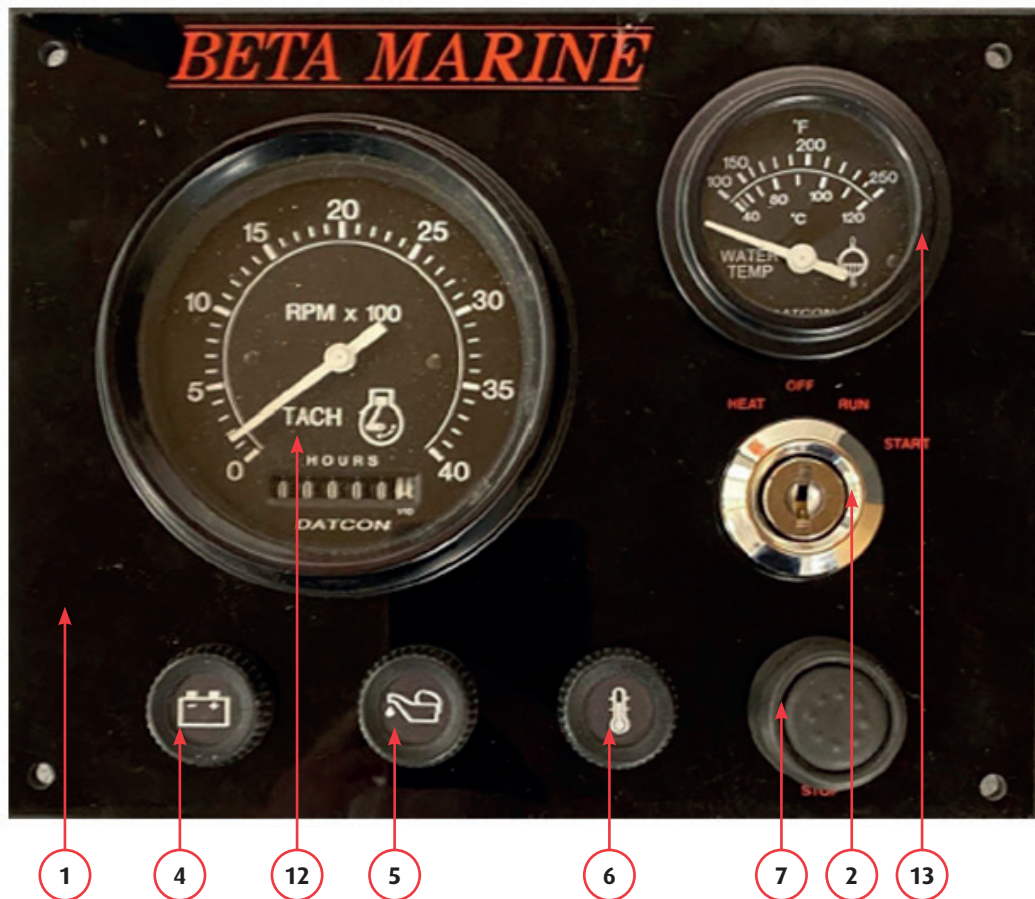

Ref.	Part No.	Description	Qty	Comments
1	200-05408	B Panel with temperature gauge (excl. tachometer - ref no 12)	1	From February 2003 - No Longer Available use AK/2BT/KSNT0
	200-60952	B Panel with voltmeter (excl. tachometer - ref no 12)		To February 2003
2	600-00057	Kubota key switch - suits small key	1	To July 2008
3	600-00058	Kubota keys (small - pair)	1	To July 2008
4	200-00059	Warning lamp battery	1	No Longer Available
5	200-00060	Warning lamp oil	1	No Longer Available
6	200-00061	Warning lamp water	1	No Longer Available
7	200-00072	Panel stop button	1	
8	200-97490	12V bulb	3	Not shown
9	200-99433	12V DC buzzer	1	Not shown, refer to page 35
10	200-98980	Panel diode pack	1	Not shown, refer to page 35
11	200-00043	B Panel blank	1	Facia only – check for availability
12	200-02373-03	0-3000 rpm tachometer & hourmeter	1	VDO From 2002 to January 2010 - No Longer Available
	200-00054	0-4000 rpm tachometer & hourmeter		DATCON To March 2002 - No Longer Available
13	200-91400	Water temperature gauge	1	From February 2003
	200-91390	Voltmeter gauge		To February 2003
14	200-00639	11 Way plug to suit male type spade	1	Not shown, refer to page 35
15	200-00048	Large shroud for 11 way plug	1	Not shown, refer to page 35
16	200-00047	Male spade for 11 way plug	11	Not shown, refer to page 35



## B Panel – LAMP Type from May 2005



Ref.	Part No.	Description	Qty	Comments
1	AK/2BT/KSO31	B Panel with temperature gauge & 3m loom	1	Complete - From May 2005
	AK/2BT/KSNT01	B Panel with temperature gauge & 3m loom		No tachometer - From June 2021
2	600-00057	Kubota key switch - suits small key	1	To July 2008
	600-00057/01	Kubota key switch - suits large key		From July 2008
3	600-00058	Kubota keys (small - pair)	1	To July 2008
	600-00058/01	Kubota keys (large - pair)		From July 2008
4	200-04657	Red 12V warning lamp & retaining clip	3	
5	200-04656	Green 12V power on lamp & retaining clip	1	
6	200-00072	Panel stop button	1	
7	200-21241	0-3000 rpm tachometer with digital hour counter	1	OCEANLINK From July 2021
	200-02373/03	0-3000 rpm tachometer with digital hour counter		VIEWLINE From January 2010 to July 2021
	200-02373/03	0-3000 rpm tachometer & hourmeter		VDO From 2002 to January 2010 - No Longer Available
8	200-96200	Water temperature gauge	1	
9	N/A	B Panel blank	1	Facia only – check for availability
10	200-04655	Alarm board with buzzer	1	Not shown, refer to page 35
11	200-00639	11 Way plug to suit male type spade	1	Not shown, refer to page 35
12	200-00048	Large shroud for 11 way plug	1	Not shown, refer to page 35
13	200-00047	Male spade for 11 way plug	11	Not shown, refer to page 35

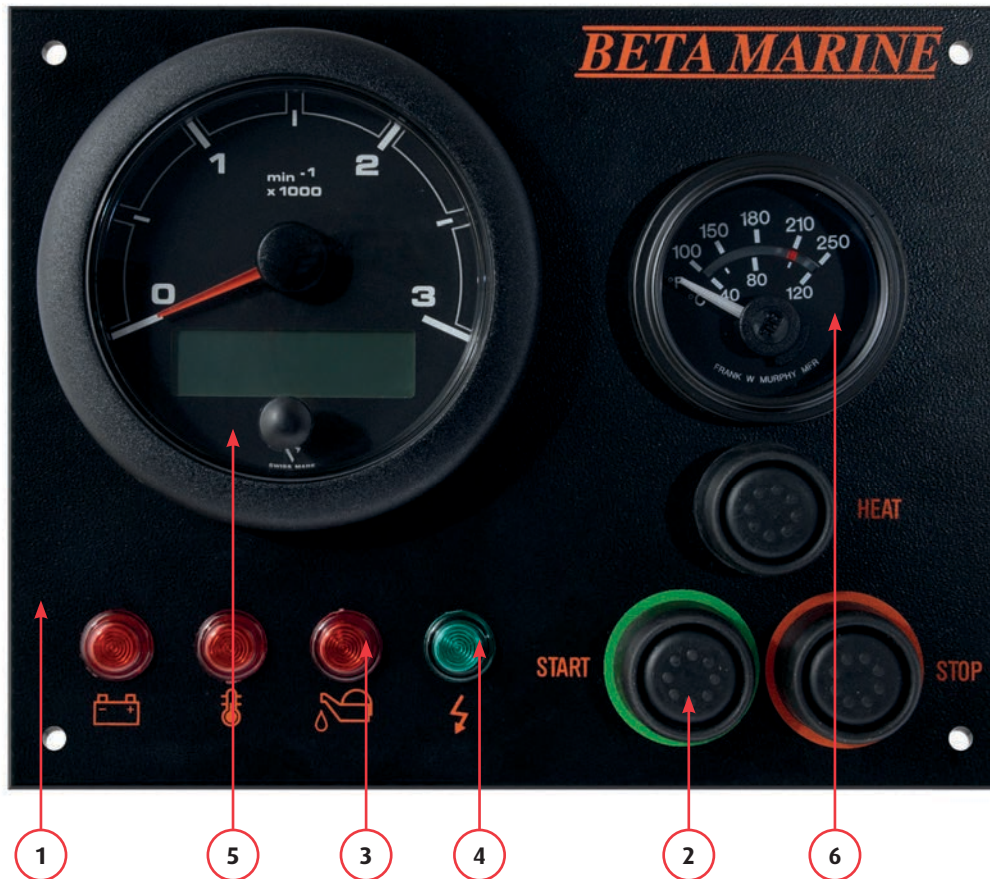

Ref.	Part No.	Description	Qty	Comments
1	AK/2BTW/KSO31	BW Panel with temperature gauge & 3m loom	1	Complete
	AK/2BTW/NT/KS31	BW Panel with temperature gauge & 3m loom		No tachometer
2	200-00072	Panel stop/start/heat button	3	
3	200-04657	Red 12V warning lamp & retaining clip	3	
4	200-04656	Green 12V power on lamp & retaining clip	1	
5	200-21241	0-3000 rpm tachometer with digital hour counter	1	OCEANLINK From December 2021
	200-02373/03	0-3000 rpm tachometer with digital hour counter		VIEWLINE From January 2010 to December 2021
	200-02373/03	0-3000 rpm tachometer & hourmeter		VDO From 2002 to January 2010 - No Longer Available
6	200-96200	Water temperature gauge	1	
7	200-00639	11 Way plug to suit male type spade	1	Not shown, refer to page 35
8	200-00048	Large shroud for 11 way plug	1	Not shown, refer to page 35
9	200-00047	Male spade for 11 way plug	11	Not shown, refer to page 35
10	200-04655	Alarm board with buzzer	1	Not shown, refer to page 35
11	200-87020	12V 28Ra 40Amp relay	2	Not shown, refer to page 35
12	200-03466	Pektron diode	1	Not shown, refer to page 35
13	200-02618	Diode bridge	1	Not shown, refer to page 35
14	AK/2ABVW/RKS01	ABVW panel service kit	1	Not shown, refer to page 23

## Deluxe C Panel – SeaSpec 4 LAMP Type to May 2005

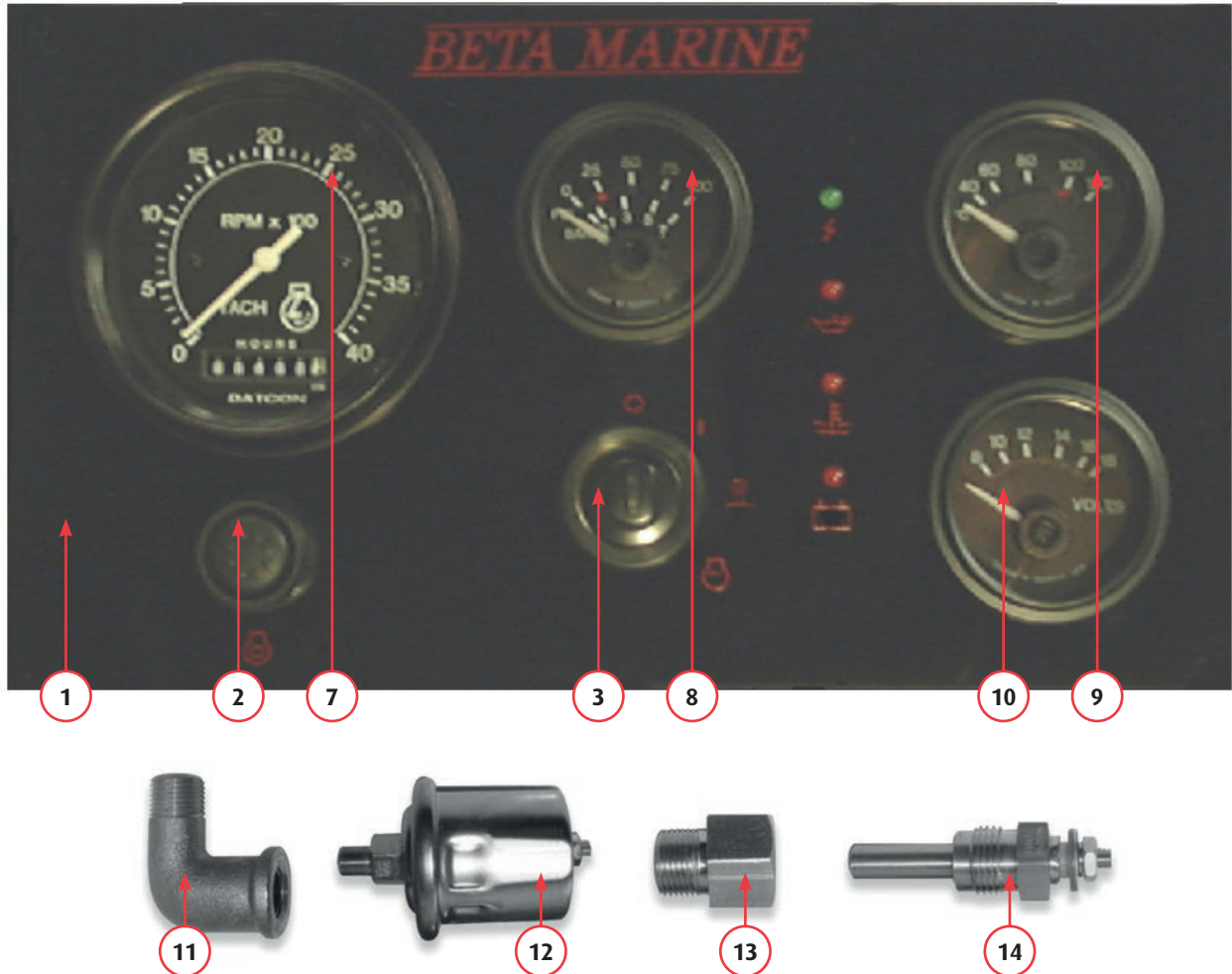

Ref.	Part No.	Description	Qty	Comments
1	200-00854	C Deluxe Panel - SeaSpec 4 Lamp (Excl. gauges & loom see ref no 7, 8, 9, 10 & 16)	1	No Longer Available - use AK/2CD/KSNT01 (No tachometer)
2	200-00072	Panel stop button	1	
3	200-00073	Murphy key switch	1	
4	200-98965	Murphy keys (pair)	1	Not shown, refer to page 35
5	200-01295	LED Pack assembly & buzzer - SeaSpec 4 Lamp	1	Not shown - Check for availability
6	200-01290	C Deluxe panel blank (SeaSpec 4 Lamp)	1	Facia only - Check for availability
7	200-02373/03	0-3000 rpm tachometer & hourmeter	1	VDO From March 2002 to May 2005 - No Longer Available
	200-00054	0-4000 rpm tachometer & hourmeter		DATCON To March 2002 - No Longer Available
8	200-96190	Oil pressure gauge	1	
9	200-96200	Water temperature gauge	1	
10	200-96210	Voltmeter gauge	1	
11	212-04355	1/8" BSP male x female elbow	1	
12	200-94350	Oil pressure sender	1	
13	200-91980	Water temperature sender adaptor	1	Alternatively you can use 1/8" sender
14	200-94360	Water temperature sender	1	200-08248 & adaptor 212-01480
15	200-93830	Murphy deluxe 3m connecting loom	1	Not shown
16	200-00046	11 Way socket to suit female type spade	1	Not shown, refer to page 35
17	200-00181	Female spade for 11 way plug	11	Not shown, refer to page 35

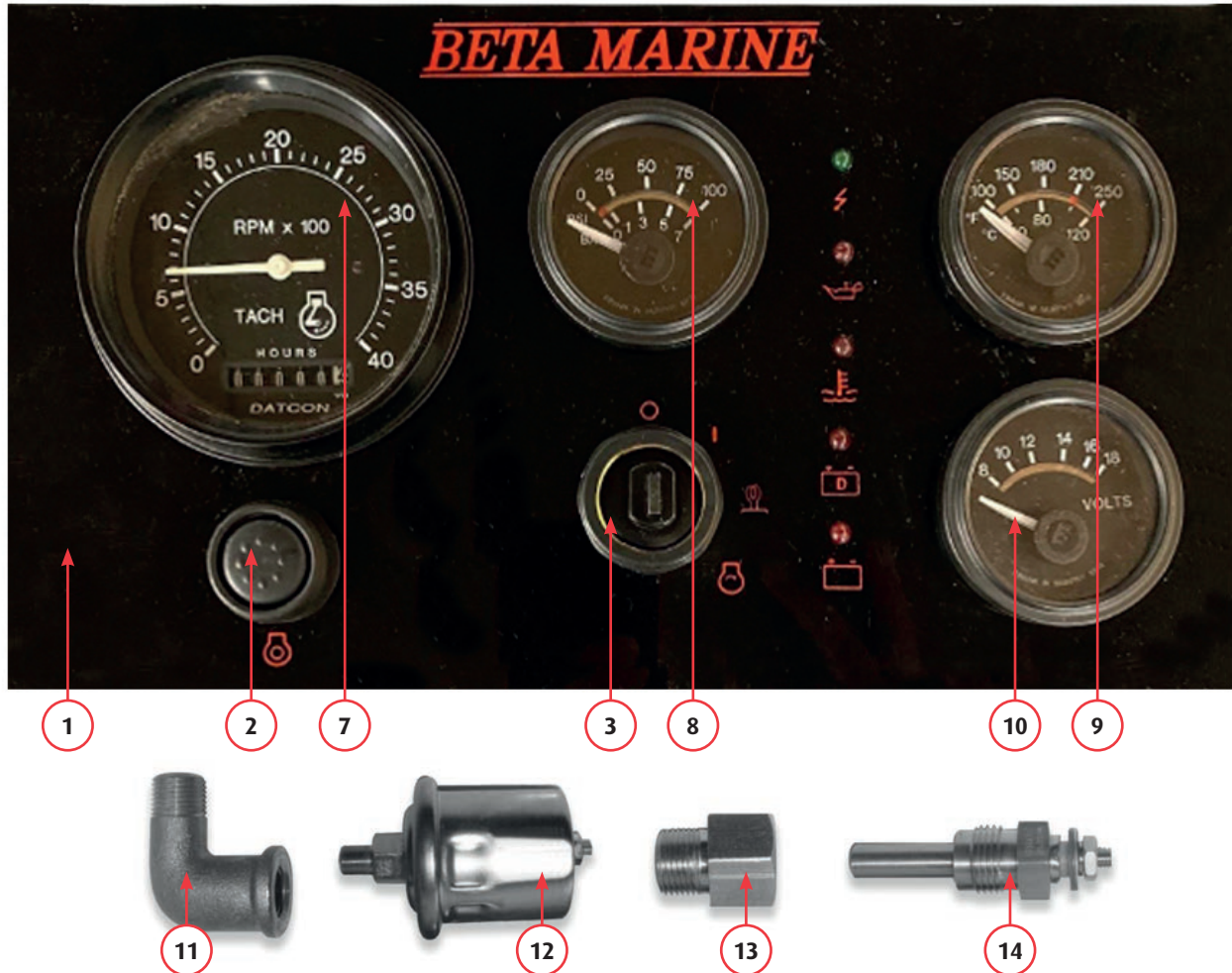

Ref.	Part No.	Description	Qty	Comments
1	200-00851	C Deluxe Panel – SeaSpec 5 Lamp (Excl. gauges & loom - ref no 7, 8, 9, 10 & 16)	1	No Longer Available - use AK/2CD/KSNT01 (No tachometer)
2	200-00072	Panel stop button	1	
3	200-00073	Murphy key switch	1	
4	200-98965	Murphy keys (pair)	1	Not shown, refer to page 35
5	200-01296	LED Pack assembly & buzzer (SeaSpec 5 Lamp)	1	Not shown – check for availability
6	200-01293	C Deluxe panel blank (SeaSpec 5 Lamp)	1	Facia only – check for availability
7	200-02373	0-4000 rpm tachometer & hourmeter	1	VDO From March 2002 to May 2005 - No Longer Available
	200-00054	0-4000 rpm tachometer & hourmeter		DATCON To March 2002 - No Longer Available
8	200-96190	Oil pressure gauge	1	
9	200-96200	Water temperature gauge	1	
10	200-96210	Voltmeter gauge	1	
11	212-04355	1/8" BSP male x female elbow	1	
12	200-94350	Oil pressure sender	1	
13	200-91980	Water temperature sender adaptor	1	Alternatively you can use 1/8" sender
14	200-94360	Water temperature sender	1	200-08248 & adaptor 212-01480
15	200-93830	Murphy deluxe 3m connecting loom	1	Not shown
16	200-00046	11 Way socket to suit female type spade	1	Not shown, refer to page 35
17	200-00181	Female spade for 11 way plug	11	Not shown, refer to page 35

## Deluxe C Panel – SeaSpec 5 LAMP Type from May 2005



Ref.	Part No.	Description	Qty	Comments
1	AK/2CD/KSOL31	C Deluxe Panel - Domestic 5 Lamp	1	3m extension harness not included - see ref no 17
	AK/2CD/KSNT01	C Deluxe Panel - Domestic 5 Lamp (No tachometer)		3m extension harness not included - see ref no 17
2	200-00072	Panel stop button	1	
3	600-00057	Kubota key switch - suits small key	1	To July 2008
	600-00057/01	Kubota key switch - suits large key		From July 2008
4	600-00058	Kubota keys (small - pair)	1	To July 2008
	600-00058/01	Kubota keys (large - pair)		From July 2008
5	200-04657	Red 12V warning lamp & retaining clip	4	
6	200-04656	Green 12V power on lamp & retaining clip	1	
7	N/A	C Deluxe panel blank (Domestic 5 Lamp)	1	Facia only – check for availability
8	200-21241	0-3000 rpm tachometer with digital hour counter	1	OCEANLINK From June 2021
	200-02373/03	0-3000 rpm tachometer with digital hour counter		VIEWLINE From January 2010 to June 2021
	200-02373/03	0-3000 rpm tachometer & hourmeter		VDO From 2002 to January 2010 - No Longer Available
9	200-96190	Oil pressure gauge	1	
10	200-96200	Water temperature gauge	1	
11	200-96210	Voltmeter gauge	1	
12	212-04355	1/8" BSP male x female elbow	1	
13	200-94350	Oil pressure sender	1	
14	200-91980	Water temperature sender adaptor	1	Alternatively you can use 1/8" sender
15	200-94360	Water temperature sender	1	200-08248 & adaptor 212-01480
16	200-04588/03	3m extension harness	1	Not shown
17	200-00639	11 Way plug to suit male type spade	1	Not shown, refer to page 35
18	200-00047	Male spade for 11 way plug	11	Not shown, refer to page 35
19	200-04583/5W	Domestic charge load resistor	1	Fits on rear of domestic charge lamp

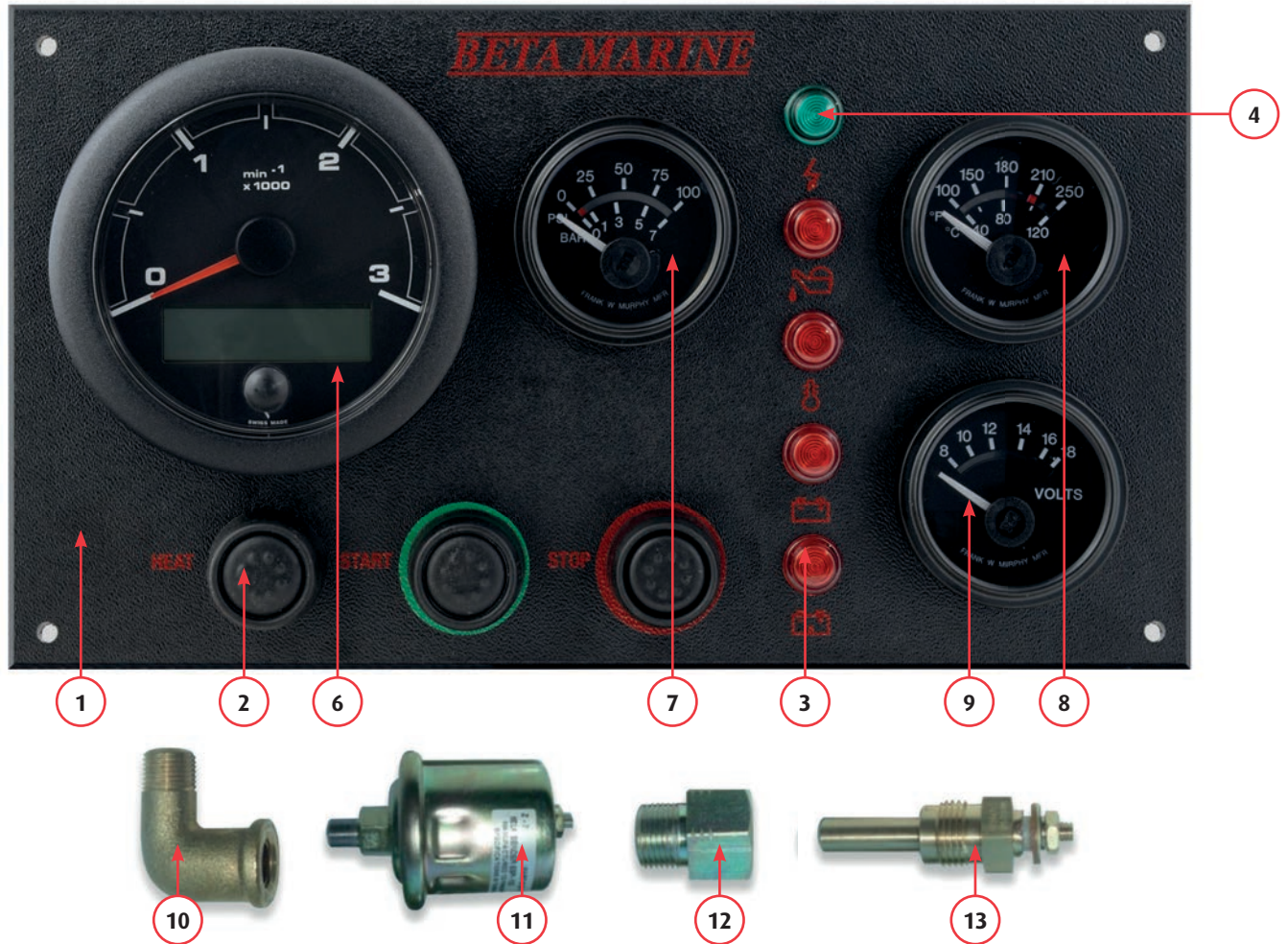

Ref.	Part No.	Description	Qty	Comments
1	AK/2CW/KSOL31	CW Panel – Domestic 5 Lamp	1	3m extension harness not included - see ref no 14
	AK/2CW/KSNT01	CW Panel – Domestic 5 Lamp (No tachometer)		3m extension harness not included - see ref no 14
2	200-00072	Panel stop/start/heat button	3	
3	200-04657	Red 12V warning lamp & retaining clip	3 or 4	
4	200-04656	Green 12V power on lamp & retaining clip	1	
5	200-01293P	CW panel blank - Domestic 5 Lamp	1	Facia only – check for availability
6	200-21241	0-3000 rpm tachometer with digital hour counter	1	OCEANLINK From June 2021
	200-02373/03	0-3000 rpm tachometer with digital hour counter		VIEWLINE From January 2010 to June 2021
	200-02373/03	0-3000 rpm tachometer & hourmeter		VDO From 2002 to January 2010 - No Longer Available
7	200-96190	Oil pressure gauge	1	
8	200-96200	Water temperature gauge	1	
9	200-96210	Voltmeter gauge	1	
10	212-04355	1/8" BSP male x female elbow	1	
11	200-94350	Oil pressure sender	1	
12	200-91980	Water temperature sender adaptor	1	Alternatively you can use 1/8" sender 200-08248 & adaptor 212-01480
13	200-94360	Water temperature sender	1	
14	200-04588/03	3m extension harness	1	Not shown
15	200-00639	11 Way plug to suit male type spade	1	Not shown, refer to page 35
16	200-00047	Male spade for 11 way plug	11	Not shown, refer to page 35
17	200-10135	Diode pack to suit CW panel from December 2015	1	Not shown, refer to page 35

## Digital D Panel

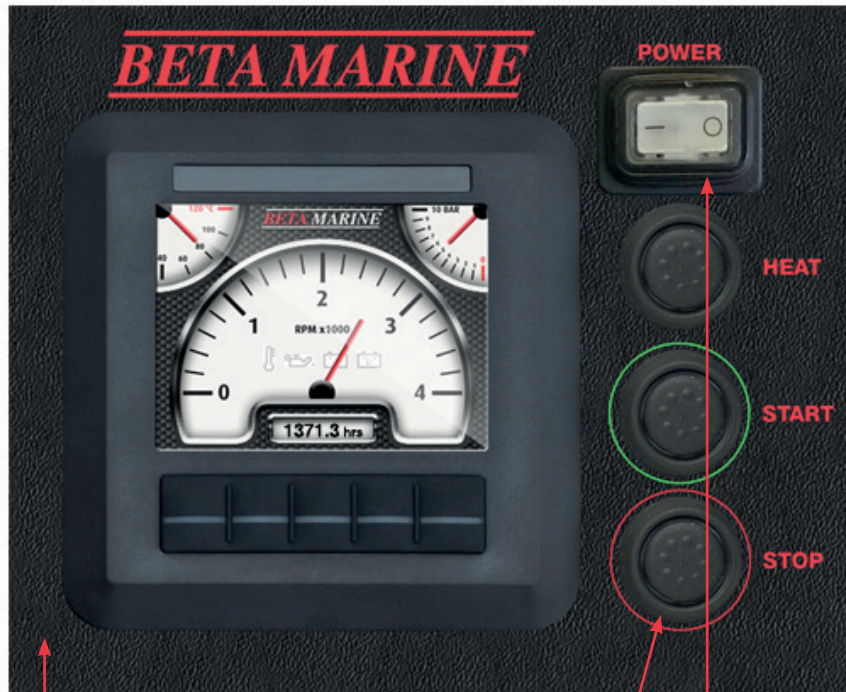

Ref.	Part No.	Description	Qty	Comments
1	AK/P/2D/KS01	D-Digital Panel	1	Requires 3m extension harness and senders - see ref no 4, 5, 6, 7 & 8
2	200-09347	Illuminated rocker switch	1	
3	200-00072	Panel stop/start/heat button	3	
4	200-04588/03	3m extension harness	1	Not shown
5	212-99397	1/8" BSP male x female elbow	1	
6	200-94350	Oil pressure sender	1	
7	200-91980	Water temperature sender adaptor	1	Alternatively you can use 1/8" sender
8	200-94360	Water temperature sender	1	200-08248 & adaptor 212-01480

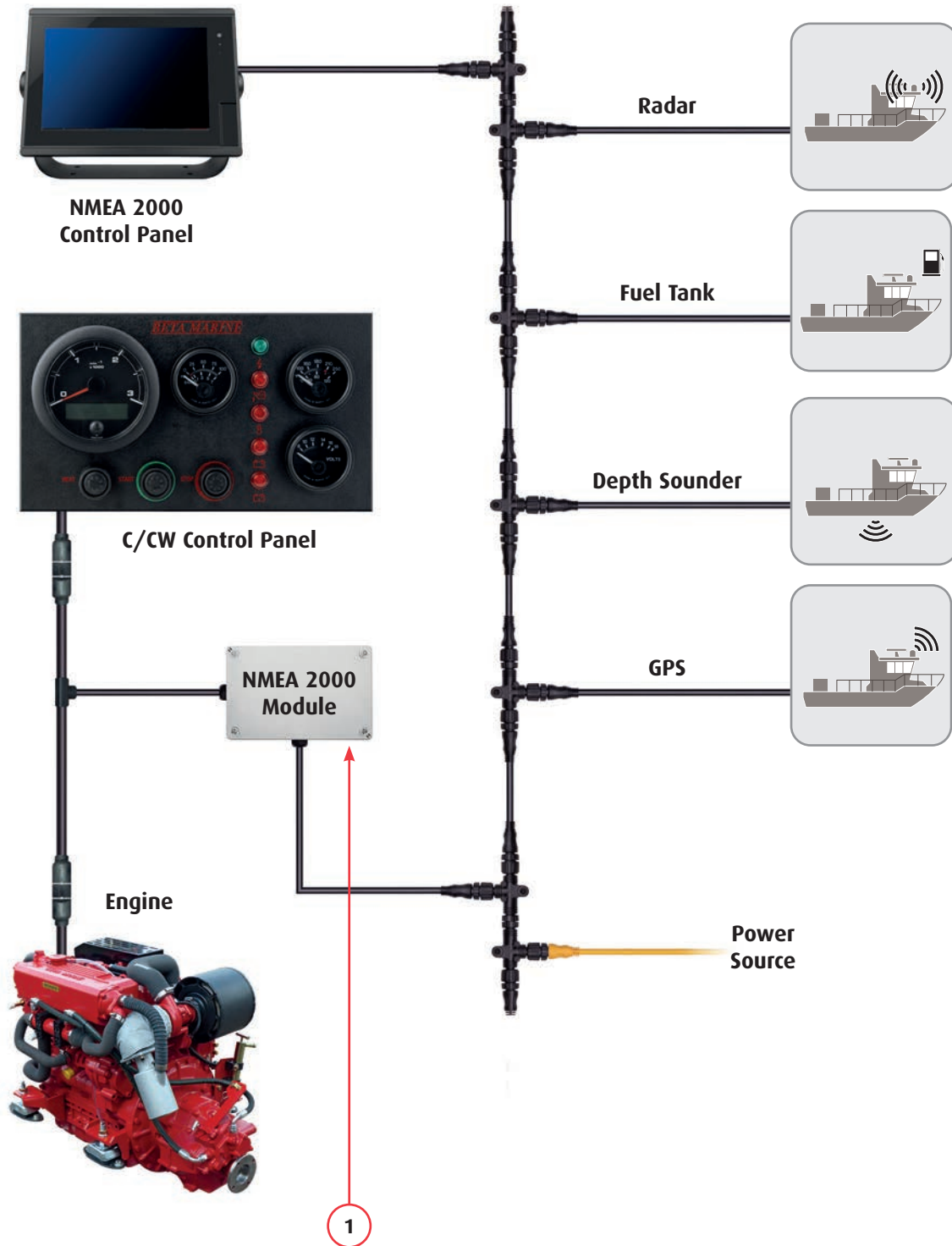

Ref.	Part No.	Description	Qty	Comments
1	AK/P/2D/i01	NMEA 2000 Module for use with C Deluxe & CW panels	1	



## Panel Gauges and Senders



Ref.	Part No.	Description	Qty	Comments
1	200-21241	0-3000 rpm tachometer with digital hour counter	1	OCEANLINK From June 2021
	200-02373/03	0-3000 rpm tachometer with digital hour counter	1	VIEWLINE From January 2010 to June 2021
	200-02373/03	0-3000 rpm tachometer & hourmeter	1	VDO From 2002 to January 2010 - No Longer Available
	200-02373	0-4000 rpm tachometer & hourmeter	1	VDO From 2002 to January 2010 - No Longer Available
	200-00054	0-4000 rpm tachometer & hourmeter	1	DATCON To March 2002 - No Longer Available
2	200-08011	Oil pressure gauge	1	VDO VIEWLINE
	200-91380	Oil pressure gauge	1	DATCON
3	200-07981	Water temperature gauge	1	VDO VIEWLINE
	200-91390	Water temperature gauge	1	DATCON
4	200-07980	Voltmeter gauge	1	VDO VIEWLINE
	200-91400	Voltmeter gauge	1	DATCON
5	200-90000	Hourmeter gauge	1	FOZMULA
6	200-01392	Gauge bulb 12V	1	DATCON
7	212-99397	1/8" BSP male x female elbow	1	
8	212-01480	3/8" BSPT M x 1/8" F adaptor tail	1	
9	200-62680	0-5 Bar switch/sender	1	
10	200-01133	Water temperature switch/sender 95°C	1	
11	200-04805	Red tachometer 12v bulb	2	VDO Not shown
12	200-96220	Tachometer bulb 12V	1	DATCON Not shown
13	200-07664	8 Pin gauge connector	1	VIEWLINE Not shown



Ref.	Part No.	Description	Qty	Comments
1	200-22729	12 Pin connector	1	For OCEANLINK gauges
2	200-07664	8 Pin connector	1	For VIEWLINE gauges
3	200-08875	Calibration wiring harness	1	For VIEWLINE tachometers
4	200-07664-OL	8 Pin connector	1	To suit OCEANLINE replacement
5	200-10381	OCEANLINE conversion harness	1	To suit VIEWLINE panel
6	200-10091B	Replacement 52mm bezel	1	For VIEWLINE gauges
7	200-10090B	Replacement 85mm bezel	1	For VIEWLINE tachometers

## Control Panel Components

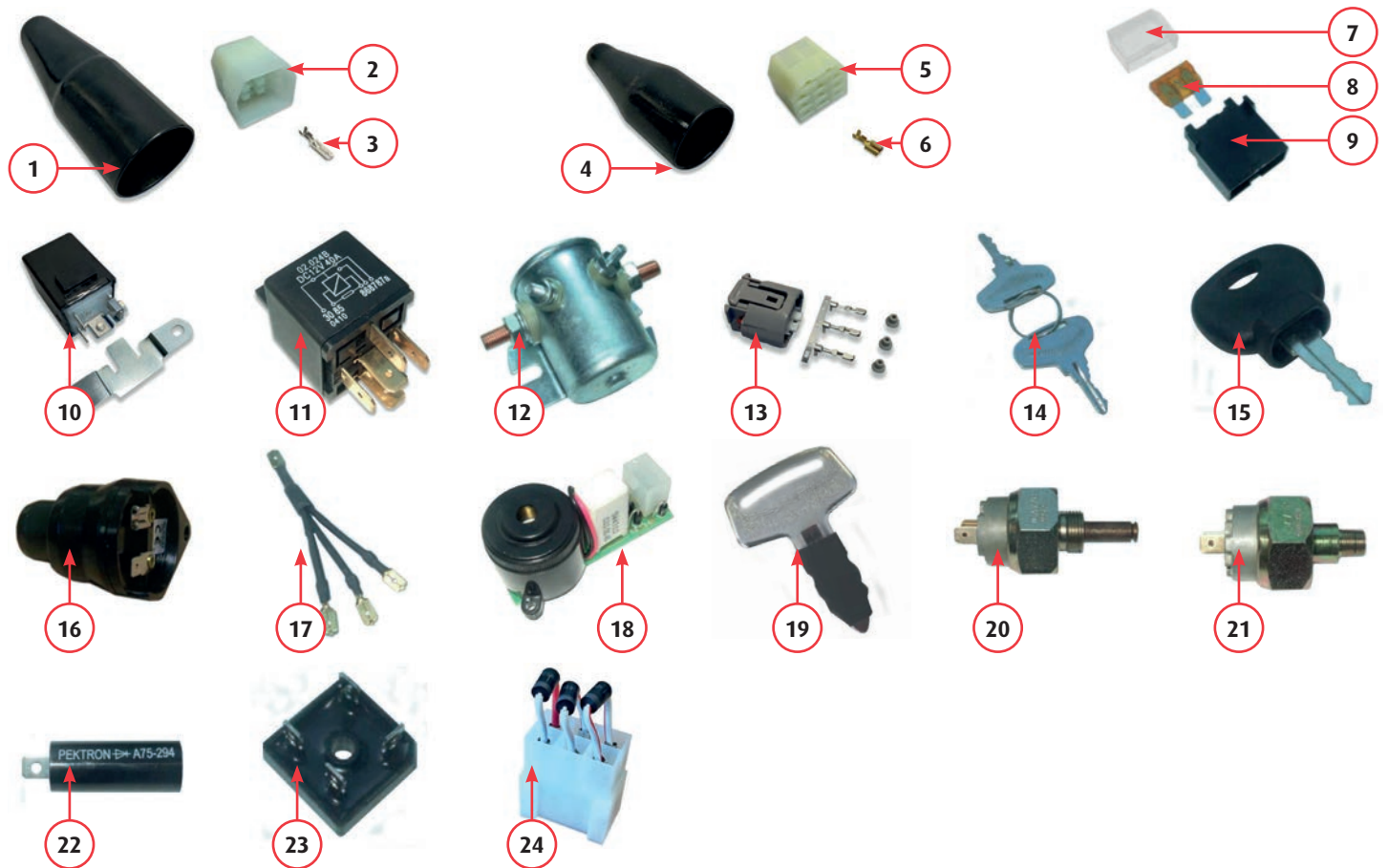

Ref.	Part No.	Description	Qty	Comments
1	200-00048	Large shroud for 11 way plug	1	On panel connection
2	200-00639	11 Way plug to suit male type spade	1	On panel connection
3	200-00047	Male spade for 11 way plug	11	On panel connection
4	200-00638	Small shroud for 11 way socket	1	On engine harness
5	200-00046	11 Way socket to suit female type spade	1	On engine harness
6	200-00181	Female spade for 11 way socket	11	On engine harness
7	200-01426	Plastic clear fuse cover	1	On engine harness
8	200-00959	40 Amp fuse blade	1	On engine harness
9	200-00640	Fuse holder for 40 Amp fuse blade	1	On engine harness
10	200-57640	12V 33Ra 70 Amp relay	1	For extended looms
11	200-87020	12V 28Ra 40 Amp relay	1	On rear of panel
12	200-89950/01	12V heavy duty relay	1	For insulated earth
13	600-02405	Kubota alternator 3 pin coupler	1	For 3 pin Denso alternator
14	600-00058	Kubota keys (small pair)	1	To July 2008
15	200-98965	Murphy keys (pair)	1	To May 2005
16	200-99433	12V buzzer	1	B panel To May 2005
17	200-98980	Panel diode pack	1	ABV To May 2005
18	200-04655	Alarm board with buzzer	1	Standard From May 2005
19	600-00058/01	Kubota keys (large pair)	1	From July 2008
20	200-02069	Water temperature switch 096C 3/8" BSP	1	Generating set standard
21	200-61190	Oil pressure switch 98kPa 1/8" BSP	1	Generating set standard
22	200-03466	Pektron diode	1	Push button panels
23	200-02618	Diode bridge	1	Push button panels
24	200-10135	Diode pack	1	CW panel From December 2015
25	200-04623	14 Core panel cable	/m	Not shown



Ref.	Part No.	Description	Qty	Comments
KIT	AK/SML/EXP/001	Expansion tank kit, complete	1	No Longer Available
1	209-03065	Expansion tank	1	
2	209-03066	Expansion tank lid	1	
3	202-21375	Expansion tank mounting bracket	1	No Longer Available
4	202-21375	Expansion tank holding band	1	No Longer Available
5	212-07011	Hose cap blanking bung	1	
6	212-07009	No 22 Stainless steel hose clip	1	
7	218-99247	3/4" Bore water hose	1m	
8	212-98464	Stainless steel hose clip 22-30mm	1	
9	212-99233	3/8" BSPT 5/8" hose tail	1	



Ref.	Part No.	Description	Qty	Comments
KIT	AK/SML/EXP/002	Expansion tank kit, complete	1	
1	209-03065	Expansion tank	1	
2	209-03066	Expansion tank lid	1	
3	202-21375	Expansion tank mounting bracket	1	
4	262-04015	Stainless steel hose clip 120-140mm	1	
5	212-07011	Hose cap blanking bung	1	
6	212-06818	Stainless steel hose clip 13-20mm	1	
7	218-99247	3/4" Bore water hose	1m	
8	212-98464	Stainless steel hose clip 22-30mm	1	
9	210-03297	3/8" BSPT x 3/4" hose tail	1	

## Replacing Sacrificial Anode & Cleaning Heat Exchanger Tubestack on V3 Series Engines - To 2019

1. The sacrificial zinc anode should be replaced every year. This can be more frequent depending on the environment the set is in. The anode is attached to the bolt inserted in the forward end cap of the heat exchanger. Please refer to image 1.
2. Unscrew the bolt and replace the complete unit with a new one.
3. Check for leaks.
4. It is possible for fine sea weed and other debris to get past the inlet filter and into the tube stack. This requires removal of the tube stack for cleaning.
5. Drain off coolant into a bucket.
6. Unscrew the 8 end cap retaining bolts using a 5mm Hex Key (four each end of the tube stack). Remove the 'O' rings and pull out tube stack. Clean tube stack and end caps.
7. Re-assemble using new 'O' rings. Do not over tighten end cap bolts and make sure the tube stack is the right way round. Please refer to image 2.
8. Make sure rear end-cap is refitted in the same orientation as it was originally to ensure sea water flows correctly through the tubestack and not straight out of the exhaust. Please refer to image 3.
9. Re-fill engine with water/anti-freeze solution and run engine up to temperature to check for leaks.

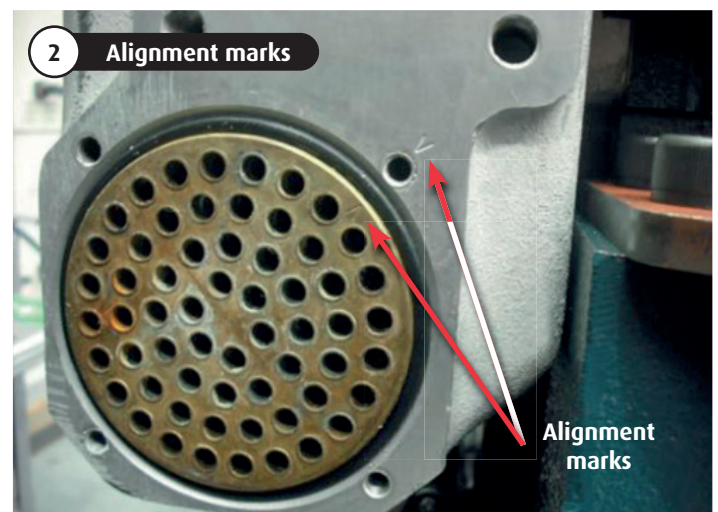
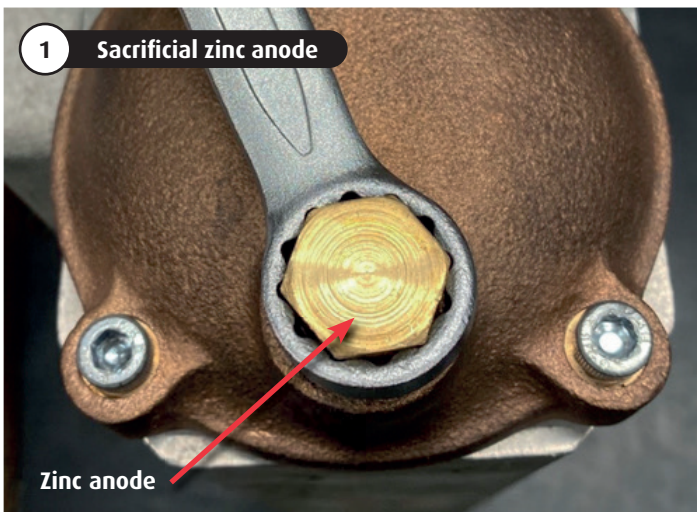

Part No.	Description	Qty
209-00814	V3 heat exchanger 'O' ring	2
209-61840	Sacrificial zinc anode	1



1. The sacrificial zinc anode should be replaced every year. This can be more frequent depending on the environment the set is in. The anode is attached to the bolt inserted in the forward end cap of the heat exchanger. Please refer to image 1.
2. Unscrew the bolt and replace the complete unit with a new one.
3. Check for leaks.
4. It is possible for fine sea weed and other debris to get past the inlet filter and into the tube stack. This requires removal of the tube stack for cleaning.
5. Drain off coolant into a bucket.
6. Unscrew the 8 end cap retaining bolts using a 5mm Hex Key (four each end of the tube stack). Remove the 'O' rings and pull out tube stack. Clean tube stack and end caps.
7. Re-assemble using new 'O' rings. Do not over tighten end cap bolts and make sure the tube stack is the right way round. Please refer to image 2.
8. Make sure rear end-cap is refitted in the same orientation as it was originally to ensure sea water flows correctly through the tubestack and not straight out of the exhaust. Please refer to image 3.
9. Re-fill engine with water/anti-freeze solution and run engine up to temperature to check for leaks.

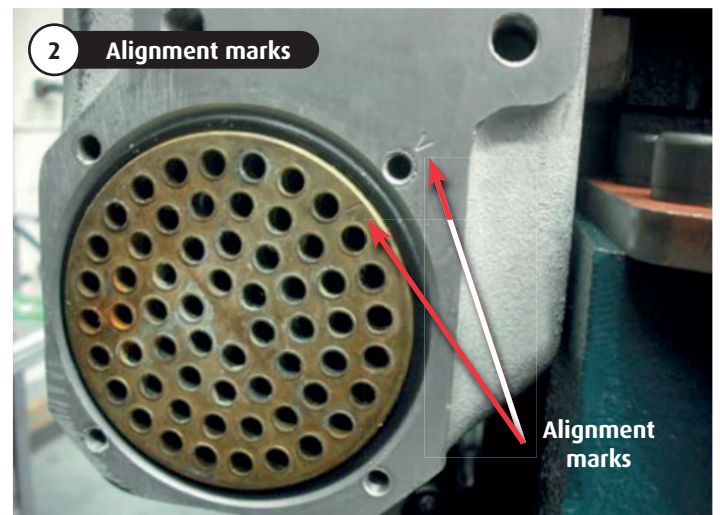
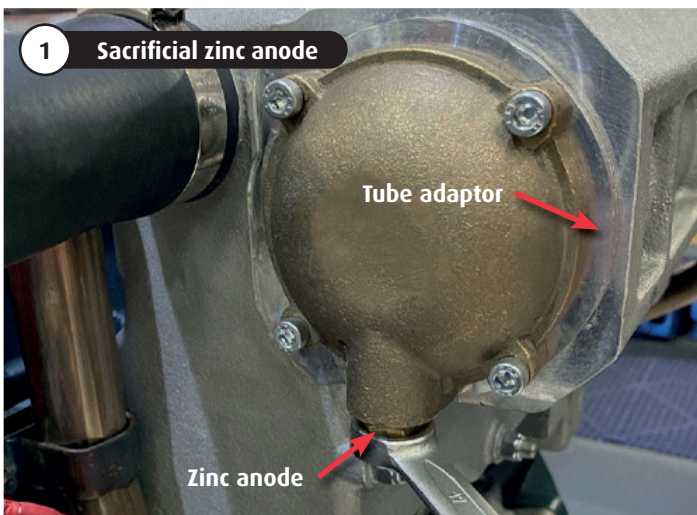

Part No.	Description	Qty
209-21737	Triple 'O' ring kit - for 2019 specification only	1
209-61840	Sacrificial zinc anode	1

**Note:** 2019 Specification heat exchanger manifolds can be identified by the use of an aluminum tube adaptor.

Located on the **forward end** for the Beta 75, 85T, 90, 90T, 105T & 115T. Located on the **aft end** for the Beta 70T.

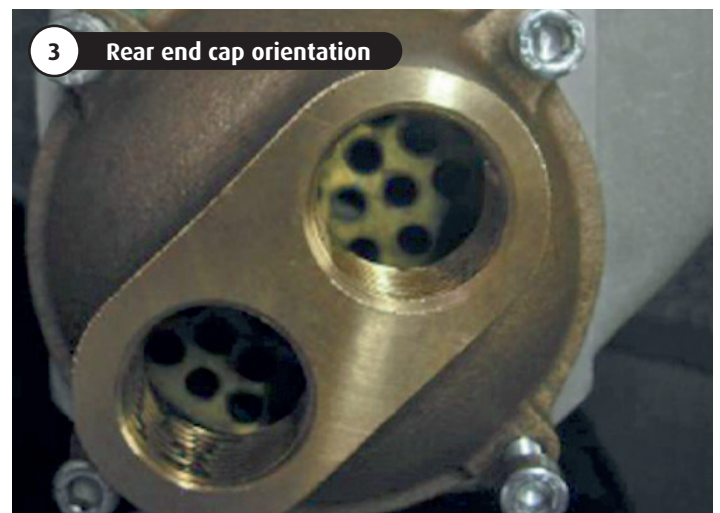

## Checking & Replacing Air Filter Element on V3 Series Engines - From Sept. 2009

Variable speed engines are fitted with a low level air intake filter which should be checked every season (or every 250 hours if sooner) and changed every two years or sooner if heavily clogged. If this occurs increase inspection frequency.

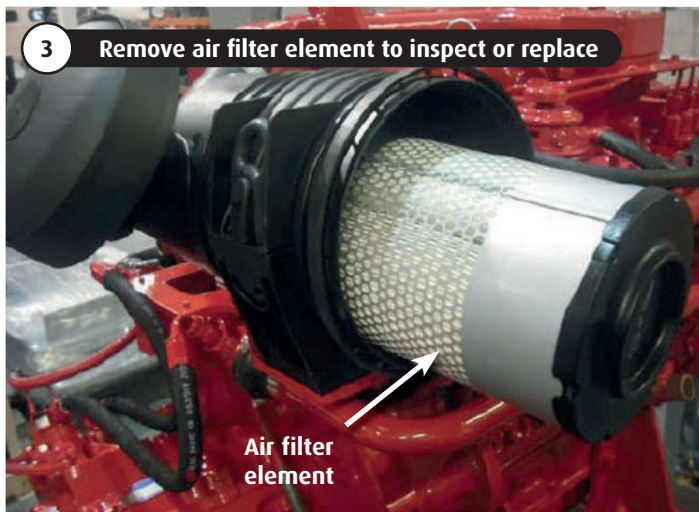
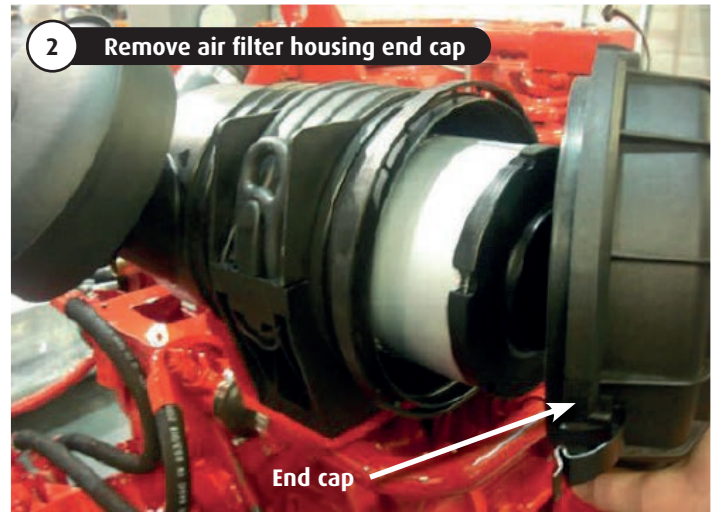
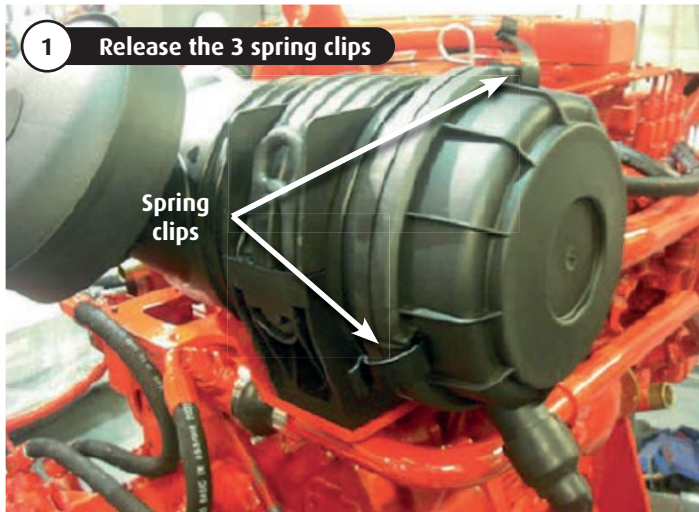

Part No.	Description	Qty
211-03819	Beta 75 & 90 air filter element	1

**Note:** Top mounted air filter elements have different part numbers, please refer to page 2.



1. Remove 3/8" BSP bung from front of engine below thermostat housing.
2. Fit 3/8" BSP male/male adaptor. Onto this, then fit female/female socket, water tap and then the 5/8" hose connector.



1. Remove 3/8" BSP bung from starboard side, under fresh water pipe.
2. Fit 3/8" BSP male x female elbow.
3. Fit water tap and 3/8" BSP x 5/8" hose connector.
4. Onto this, then fit female/female socket, water tap and then the 5/8" hose connector.

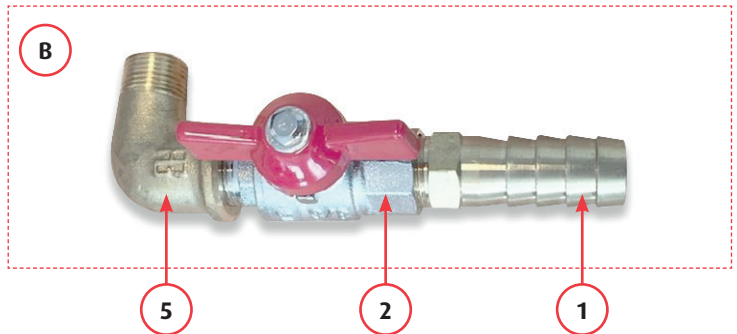
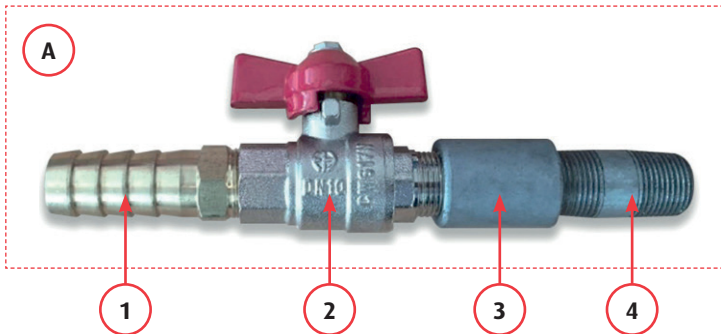

Ref.	Part No.	Description	Qty	Comments
Kit	AK/3300/CAL/001	Calorifier kit and sub components	1	Includes parts A & B
1	212-99233	5/8" hose connector	1 or 2	
2	210-94530	Water tap	1 or 2	
3	212-00904	3/8" BSP female/female socket	1	
4	212-99405	3/8" BSP male/male adaptor	1	
5	212-99237	3/8" BSP male x female elbow	1	

**Note:** All fittings to be sealed with PTFE tape or pipe sealant to prevent water leaks when engine is at operating temperature and pressure.



## Installation Kits



Ref.	Part No.	Description	Qty	Comments
1	AK/MID/HE/6e/001	Water Inlet Kit - 1 1/4" ID	1	
2	AK/B75/HE/6B/001	Water cooled exhaust kit 60mm	1	V3 non turbo
	AK/B115/HE/6B/001	Water cooled exhaust kit 90mm		V3 turbocharged
3	AK/B75/HE/6C/001	Plastic waterlock kit 60mm	1	V3 non turbo - including 4x hose clips
	AK/B115/HE/6C/001	Plastic waterlock kit 90mm		V3 turbocharged - including 4x hose clips
4	212-00466	Anti-Siphon kit with vent	1	
5	AK/SML/6g/001	Flexible fuel pipes 24" OAL ISO7840	1	
	AK/SML/6k/001	Fuel delivery kit		
6	AK/SML/6k/001	Fuel leak off kit	1	
	AK/SML/6l/H01	Fuel/water separator kit		1
AK/SML/6l/001	Keel cooled 8mm compression			
8	AK/6H/HE/KS01	Electric fuel lift kit 12v	1	Supplied with connections for both heat exchanger and keel cooled engines
9	AK/MID/3h/001	Remote oil filter kit	1	Beta 75, 90, 90T, 105T & 115T
	AK/B70/3h/001			Beta 70T
	AK/B85/3h/001			Beta 85T
10	AK/SML/5a/002	Single lever control	1	
11	212-96070/01	Single lever control cables 3m	1	
12	200-96160/V3/1.5	Battery leads 1.5m, 35mm (x1 black & x1 red)	1	All V3 engines

## Heat Exchanger Cooled

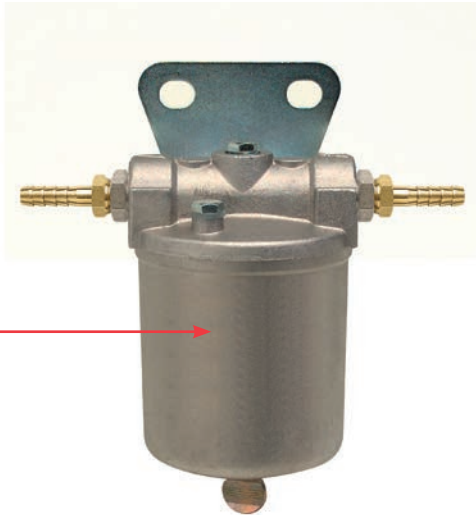

## Keel Cooled

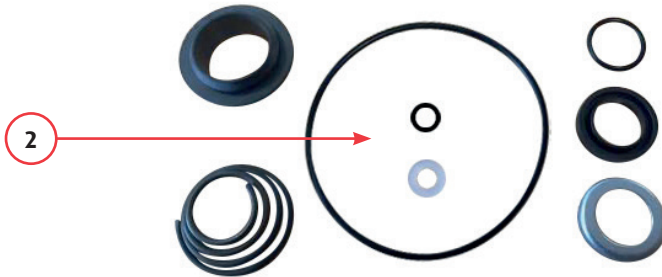
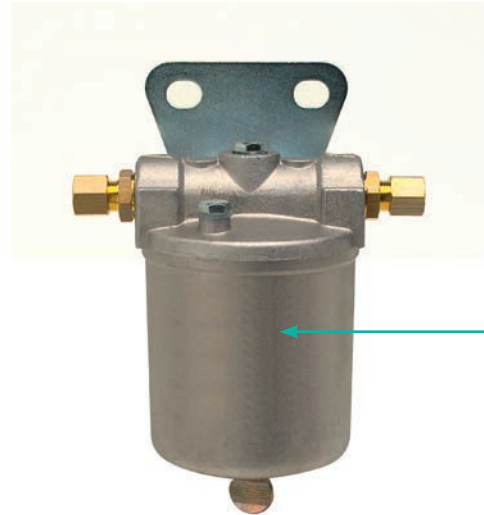

Ref.	Part No.	Description	Qty	Comments
1	AK/SML/6l/H01	Fuel/water separator - heat exchanger cooled	1	8mm hose tails
	AK/SML/6l/001	Fuel/water separator - keel cooled		8mm compression
2	212-02632	Seal kit for separator	1	
3	212-02631	Filter for separator	1	

# ***BETA MARINE***

Notes...

