



Description		Part No.	Quantity
Heat Exchanger 'O' Ring	Triple 'O' Ring Kit for 2019 Spec. Only	209-21737	1
	To 2019	209-00814	2
Tube Adaptor	For 3rd 'O' Ring for 2019 Spec. Only	201-10963	1
Sacrificial Zinc Anode		209-61840	1
Exhaust Gasket		600-98960	1
Pressure Cap		209-80130	1
90mm Water Injection Bend	Beta 70T	202-21015	1
	Beta 85T	202-10050	
Thermostat		600-07489	1
Thermostat Gasket		600-10006	1
Drive Plate	SAE10 - PRM260	206-97010	1
	SAE10 - PRM500	206-04295	
	SAE10 - ZF25/BW71C	206-00090	
Standard Kubota alternator	Alternator	600-00632	1
	V Belt - Standard - Check Before Ordering	600-10641	1
	6PK PolyVee Drive Belt - Check Before Ordering	214-04821	
70 Amp insulated return alternator in lieu of standard	Alternator	200-01384	1
	V Belt - Check Before Ordering	214-99271	1
	6PK PolyVee Drive Belt - Check Before Ordering	214-04821	
120 Amp alternator in lieu of standard	Alternator	AK/A/120A/ Beta70/KS01	1
	6PK PolyVee Drive Belt - Check Before Ordering - From May 2021	214-04124	1
	6PK PolyVee Drive Belt - Check Before Ordering - To May 2021	214-04821	
175 Amp alternator in lieu of standard	Alternator	200-05261	1
	Beta 70T 6PK PolyVee Drive Belt - Check Before Ordering	214-01147	1
	Beta 85T 6PK PolyVee Drive Belt - Check Before Ordering	214-92105	
175 Amp alternator - 2nd domestic	Alternator	200-05261	1
	Beta 70T 6PK PolyVee Drive Belt - Check Before Ordering	214-01469	1
	Beta 85T 6PK PolyVee Drive Belt - Check Before Ordering	214-09643	
Fuel Filter (Kubota Plunger Type)		211-02817	1
Oil Filter Element		211-70510/02	1
Air Cleaner Element		211-08134	1
Beta Marine Gear Driven Sea Water Pump	Pump	207-10723	1
	Impeller	207-10709	1
	Cover Plate 'O' Ring	207-10159	1
	End Cover Plate Screw	207-09483	5

## Quick Reference Tables

Description		Part No.	Quantity
Heat Exchanger Tubestack	Beta 70T & 85T - From 2019	209-10964	1
	Beta 85T - To 2019	209-02846	1
Fuel Lift Pump		600-01466	1
Fuel Lift Pump Gasket		600-00065	1
Fuel Stop Solenoid	Energised to Run	600-02244	1
	Plug	600-07330	1
	'O' Ring	600-11047	1
Control Panel Standard Key	From June 2008	600-00058/01	A pair
Control Panel Key Switch	From June 2008	600-00057/01	1
Control Panel Stop Button	Also ABVW, BW & CW Panel Heat & Start	200-00072	1
Tachometer	0-3000 rpm with Digital Hour Counter	200-21241	1
Water Temperature Gauge	For B, BW, C Deluxe & CW Control Panels	200-96200	1
Oil Pressure Gauge	For C Deluxe & CW Control Panels	200-96190	1
Voltmeter	For C Deluxe & CW Control Panels	200-96210	1
Green Power On Indicator	Lamp & Retaining Clip (P/N 200-09797)	200-04656	1
Red Warning Indicator	Lamp & Retaining Clip (P/N 200-09797)	200-04657	3 or 4
Alarm Board	ALL Panels - From June 2005	200-04655	1
Relay 12 Volt 40A (28Ra)	Fitted to the Rear of Panels	200-87020	1
40 Amp Fuse Blade		200-00959	1
Standard Engine Harness	Beta 70T & 85T	200-10468	1
Water Temperature Switch	For A, ABV & ABVW Panels	600-62820	1
Water Temperature Sender	1/8" BSP For B, BW, C Deluxe & CW Control Panels - From April 2011	200-08248	
Water Temperature Sender	5/8" UNF For B, BW, C Deluxe & CW Control Panels - To April 2011	200-94360	
Water Temperature Switch	For Insulated Earth Return Engines & Panels	200-08830	1
Oil Pressure Switch	For A, ABV, ABVW, B & BW Panels	600-62670	
Oil Pressure Sender	For C Deluxe & CW Control Panels	200-94350	
Oil Pressure Switch	For Insulated Earth Return Engines & Panels	200-61190	1
Panel A - Key Switch		AK/2AS/KS01	
Panel AB - Key Switch	0-3000 rpm Tachometer with Digital Hour Counter	AK/2ABD/KS031	
Panel ABV - Key Switch	0-3000 rpm Tachometer with Digital Hour Counter	AK/2ABV/KS0L301	
Panel ABVW - Push Button	0-3000 rpm Tachometer with Digital Hour Counter	AK/2ABVW/KS031	
Panel B - Key Switch	0-3000 rpm Tachometer with Digital Hour Counter & Temperature Gauge	AK/2BT/KS031	
Panel BW - Push Button	0-3000 rpm Tachometer with Digital Hour Counter & Temperature Gauge	AK/2BTW/KS031	

Description		Part No.	Quantity
Panel C - Key Switch	0-3000 rpm Tachometer with Digital Hour Counter, Temperature, Oil Pressure & Voltage Gauges	AK/2CD/KSOL31	1
Panel CW - Push Button	0-3000 rpm Tachometer with Digital Hour Counter, Temperature, Oil Pressure & Voltage Gauges	AK/2CW/KSOL31	
NMEA 2000 Module	Allows C & CW Panels to Interface with a NMEA 2000 Network	AK/P/2D/i01	
D-Digital - Push Button	Fully Digital Stand Alone or Fully NMEA 2000 Network Compatible Panel	AK/P/2D/KS01	
Exhaust Manifold Gasket	Beta 70T	600-21688	1
	Beta 85T	600-11214	
Top Gasket Set	Beta 70T	600-21690	1
	Beta 85T	600-11215	
Lower Gasket Set	Beta 70T	600-21691	1
	Beta 85T	600-11216	
Inlet Manifold Gasket	Beta 70T	600-21689	1
	Beta 85T	600-11213	
Rocker Cover Gasket	Beta 70T	600-23817	1
	Beta 85T	600-23816	
Flexible Mounts	Large 55 Shore Metalastic Type	213-96970/01	4
Replacement Dipsticks	Beta 70T	600-23819	1
	Beta 85T	600-23185	
	Beta 85T Dipstick Guide	600-23184	

Manuals		Part No.	Quantity
Operators Maintenance Manual		221-20031	1
Workshop Manual – Base Engine Only	Beta 70T & 85T	600-21827	1 available as a PDF
Spare Parts Manual – Base Engine Only	Beta 70T (BV2607DI-T)	600-22105	2 available as a PDF
	Beta 85T (BV3307DI-T)	600-22106	

**Note:** the above part numbers are suitable for earth return installations only (where the battery negative cable is connected directly to engine earth/ground). For insulated earth (where battery negative cable is isolated from engine earth/ground) different harnesses, alternators, switches for oil pressure and engine temperature will be required.

If your application is wired as insulated earth return and the engine will not operate correctly, always check starter battery negative is connected to the correct terminal on the isolating solenoid. It should be connected to the terminal which is also used for all the small black wires, NOT the terminal with the single black wire connected directly to engine ground.



## Fuel Filter Identification

Any engine equipped with a square fuel filter assembly with priming button requires a fuel filter with the part number:

**211-60210**

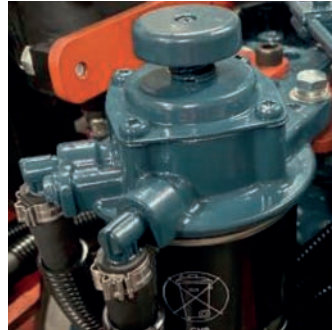

Any engine equipped with a round fuel filter assembly with priming button requires a fuel filter with the part number:

**211-02817**



## Heat Exchanger Cooled

### IPL Beta 70T & Beta 85T (T-turbocharged) - Port View

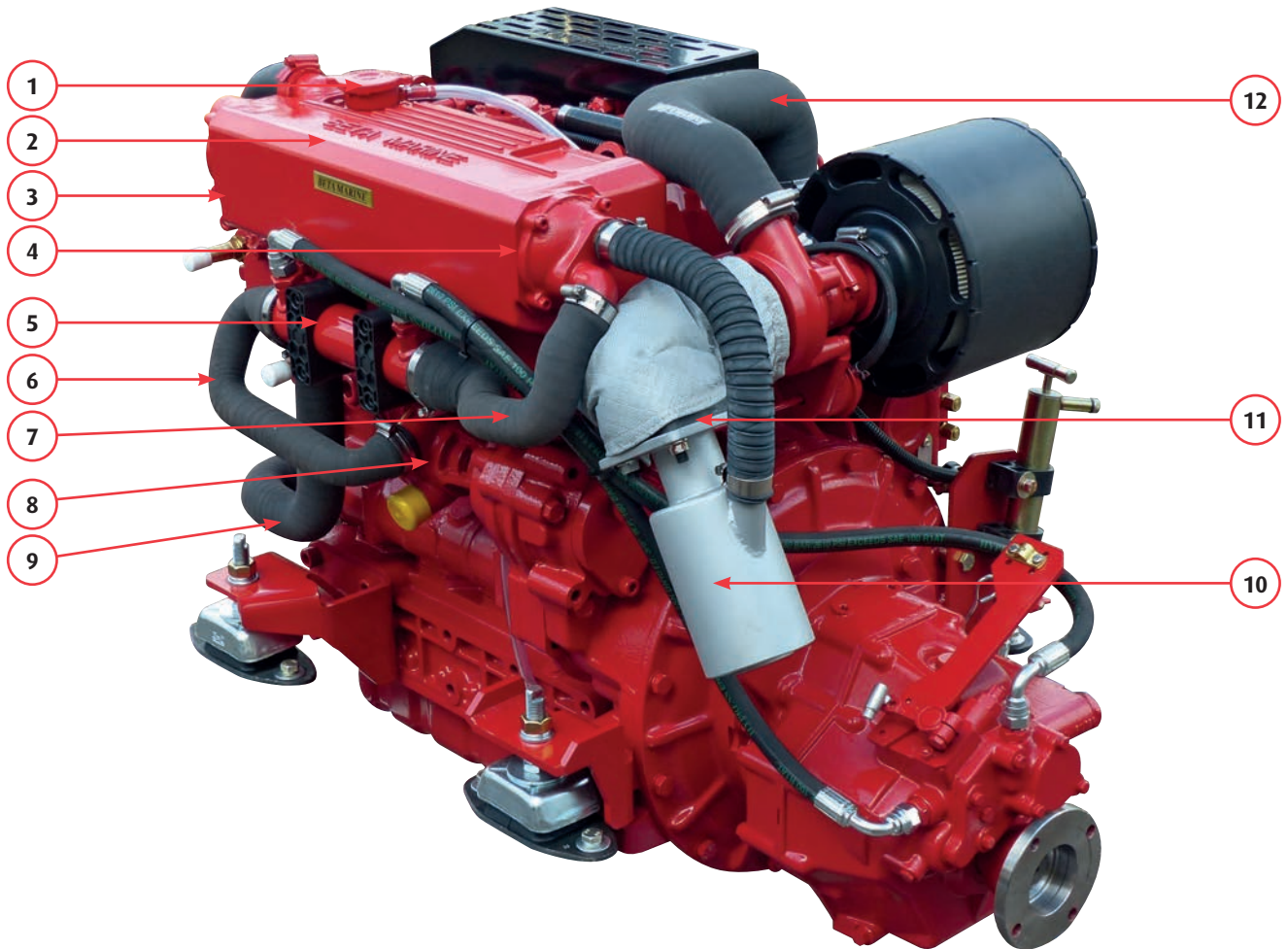

Ref.	Part No.	Description	Qty	Comments
1	209-80130	Pressure cap	1	
2	209-10131	Heat exchanger manifold	1	Beta 70T
	209-22405			Beta 85T
3	600-21688	Heat exchanger manifold gasket	1	Beta 70T
	600-11214			Beta 85T
4	209-21737	'O' ring kit	1	
5	210-82931	Side mounted gearbox oil cooler	1	
6	218-10051-B	Sea water pipe - pump to oil cooler	1	
7	218-10051-C	Sea water pipe - oil cooler to heat exchanger	1	
8	207-10723	Sea water pump	1	
9	218-10051-A	Fresh water pipe	1	
10	202-21015	76mm (3") water injection bend	1	Beta 70T
	202-10050	90mm (3.5") water injection bend		Beta 85T
	AK/V3H/Beta85WIB/H01	Optional high rise adaptor		Not shown
11	600-98960	Exhaust elbow gasket	1	
12	202-10322	Turbo inlet hose	1	Beta 70T
	202-10041			Beta 85T

## Beta 70T & Beta 85T (T-turbocharged) - Starboard View

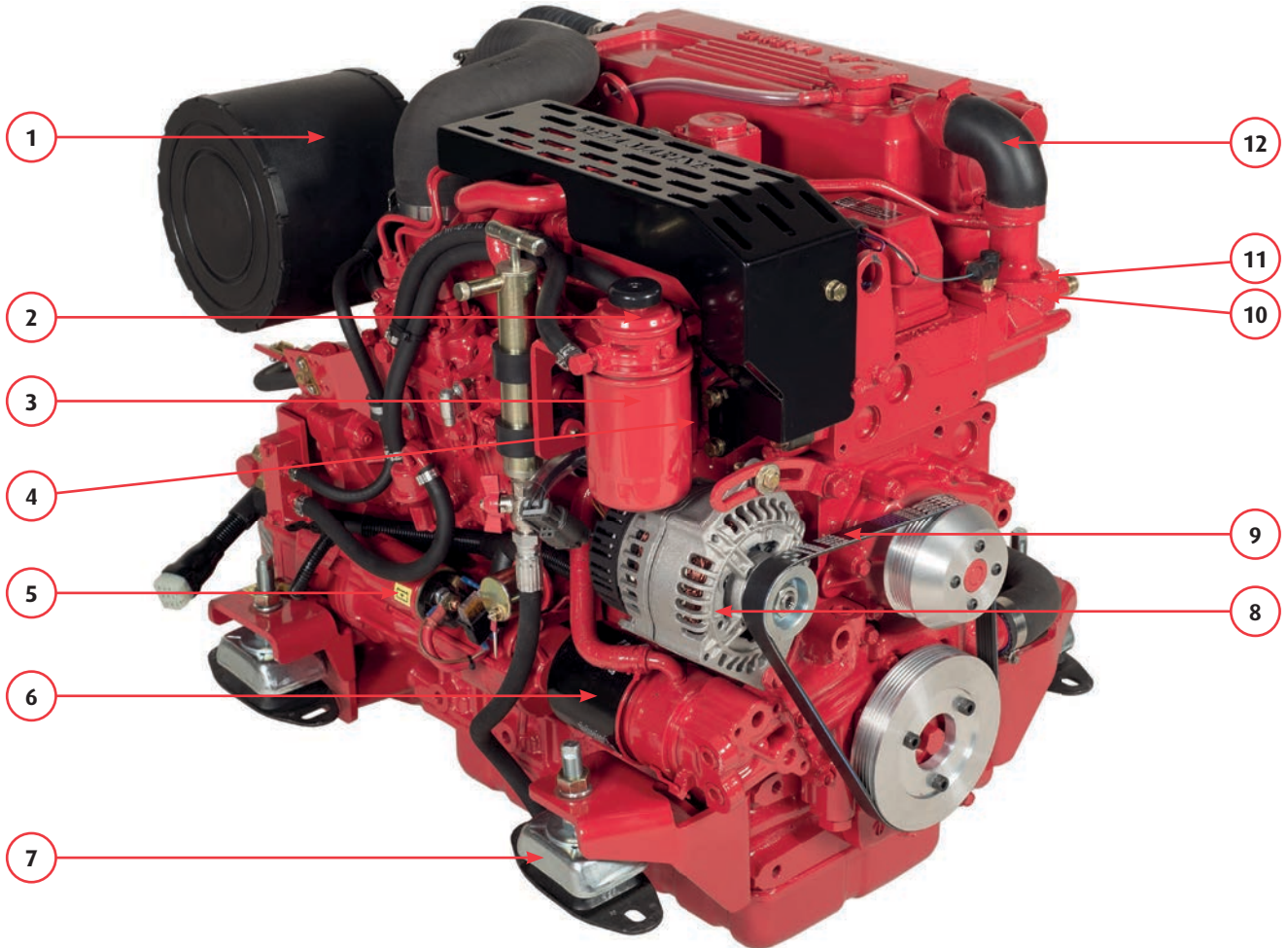

Ref.	Part No.	Description	Qty	Comments
1	211-08134	Air filter cartridge assembly	1	
2	600-01039	Fuel filter head	1	
3	211-02817	Fuel filter	1	
4	600-02244	Fuel stop solenoid	1	
5	600-10868	Stater motor	1	Beta 70T
	600-21163			Beta 85T
6	211-70510/02	Oil filter	1	
7	213-96970/01	55 shore flexible mount	4	
8	600-00632	65 Amp alternator	1	Standard
	AK/A/120A/Beta70T/KS01	120 Amp alternator		Optional
	200-05261	175 Amp alternator		Optional
9	214-94260	65 Amp alternator V belt	1	Standard
	214-04821	65 Amp alternator 6PK polyvee belt		Optional
	214-04821	120 Amp alternator 6PK polyvee belt		
	214-92105	175 Amp alternator 6PK polyvee belt		
10	600-07489	Thermostat	1	
11	600-10006	Thermostat gasket	1	
12	209-61840	Thermostat housing to heat exchanger hose pipe	1	Suits 2x stainless steel hose clip 212-00448

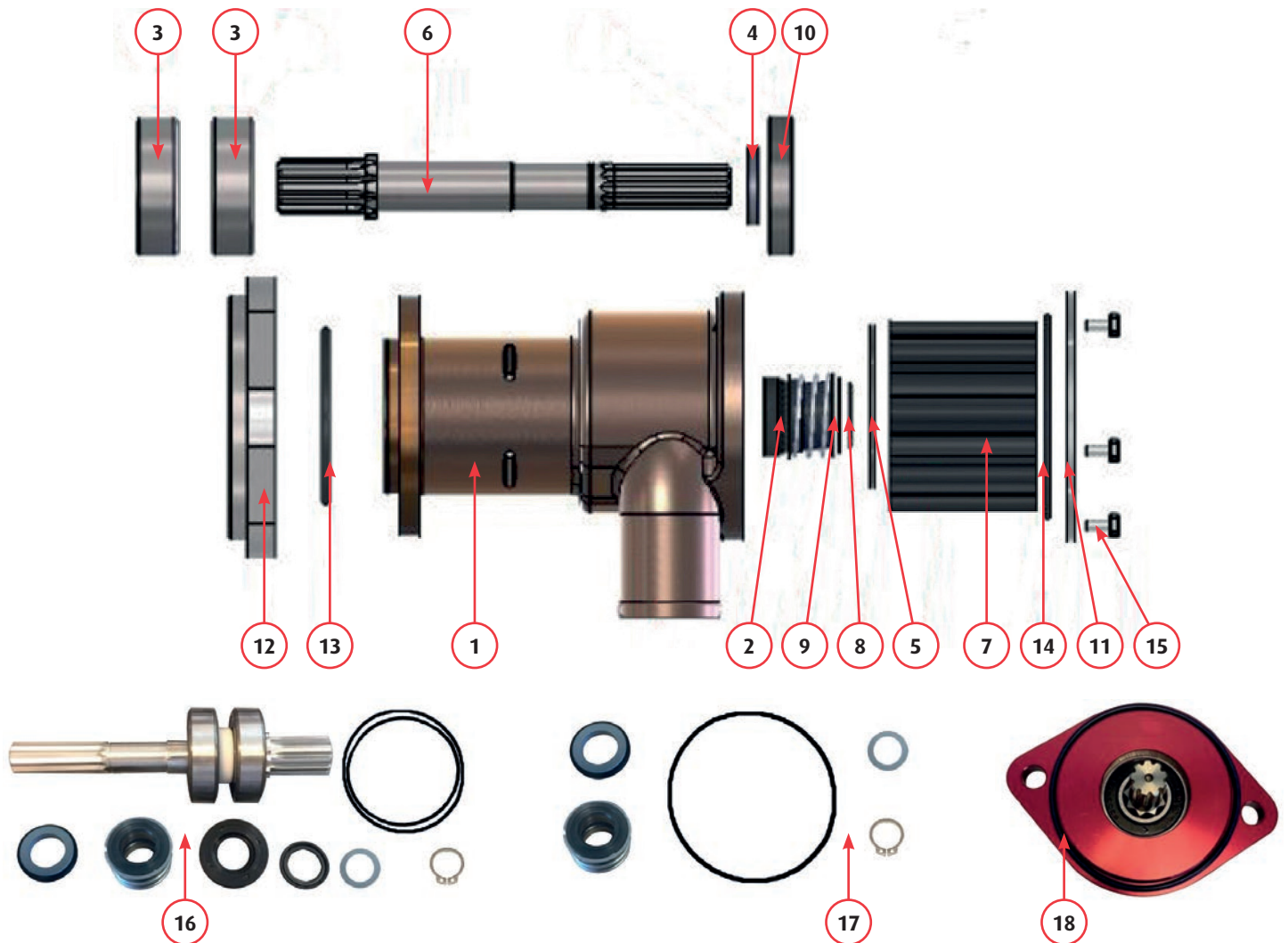

Ref.	Part No.	Description	Qty	Comments
1	207-10723	Sea water pump - complete	1	Includes red front clamp - ref no 12
2	207-10505	Mechanical Seal 16mm	1	Also part of seal kit 207-10802
3	N/A	Sealed bearing	2	N/A - part of shaft kit 207-21888
4	N/A	Oil seal	1	N/A - part of shaft kit 207-21888
5	207-21032	Wear plate	1	
6	N/A	Shaft	1	N/A - part of shaft kit 207-21888
7	207-10709	Impeller	1	
8	N/A	External circlip	1	N/A - part of shaft kit 207-21888
9	N/A	Thrust washer	1	N/A - part of shaft kit 207-21888
10	N/A	Bearing spacer	1	N/A - part of shaft kit 207-21888
11	207-10799	Cover plate	1	
12	N/A	Front clamp	1	N/A - part of 207-10723
13	N/A	'O' ring, front clamp	1	N/A - part of 207-10723
14	207-10159	'O' ring, cover plate	1	Also part of shaft kit 207-21888
15	207-09483	End cover screw	5	
16	207-21888	Shaft kit to suit 207-10723 only	1	Includes 3, 4, 6, 8, 9 & 14
17	207-10802	Seal kit	1	Includes 2, 8, 9 & 14
18	600-00246	'O' ring, sea water pump to engine	1	



## Johnson 1" 12 Volt Clutched Pump

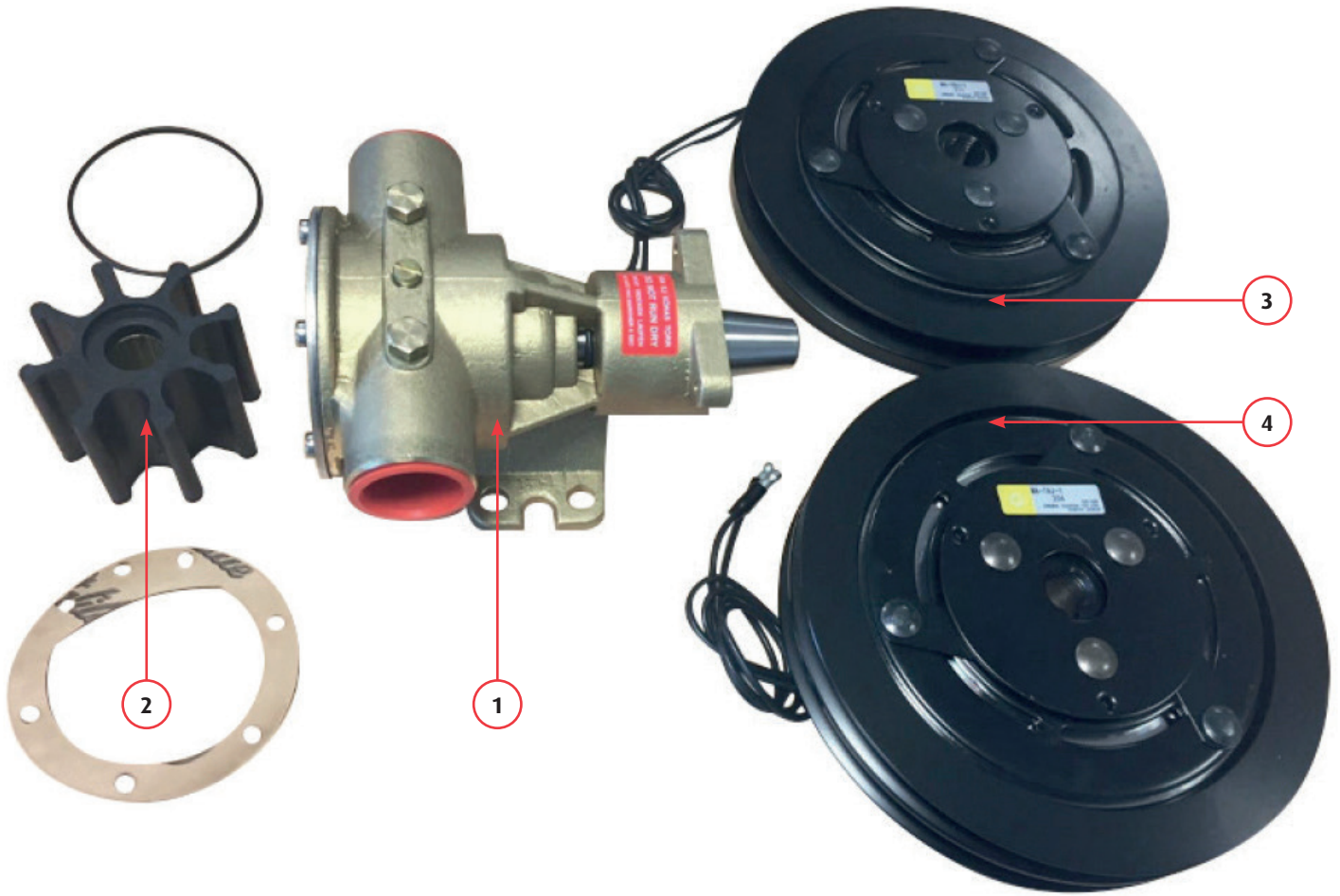

Ref.	Part No.	Description	Qty	Comments
1	207-07685	Sea water pump - complete	1	
2	207-10709	Impeller kit	1	
3	207-09856	Electro magnetic 12v clutch & 1 x SPB pulley	1	
4	207-07685/01	Electro magnetic 12v clutch & 2 x SPB pulley	1	

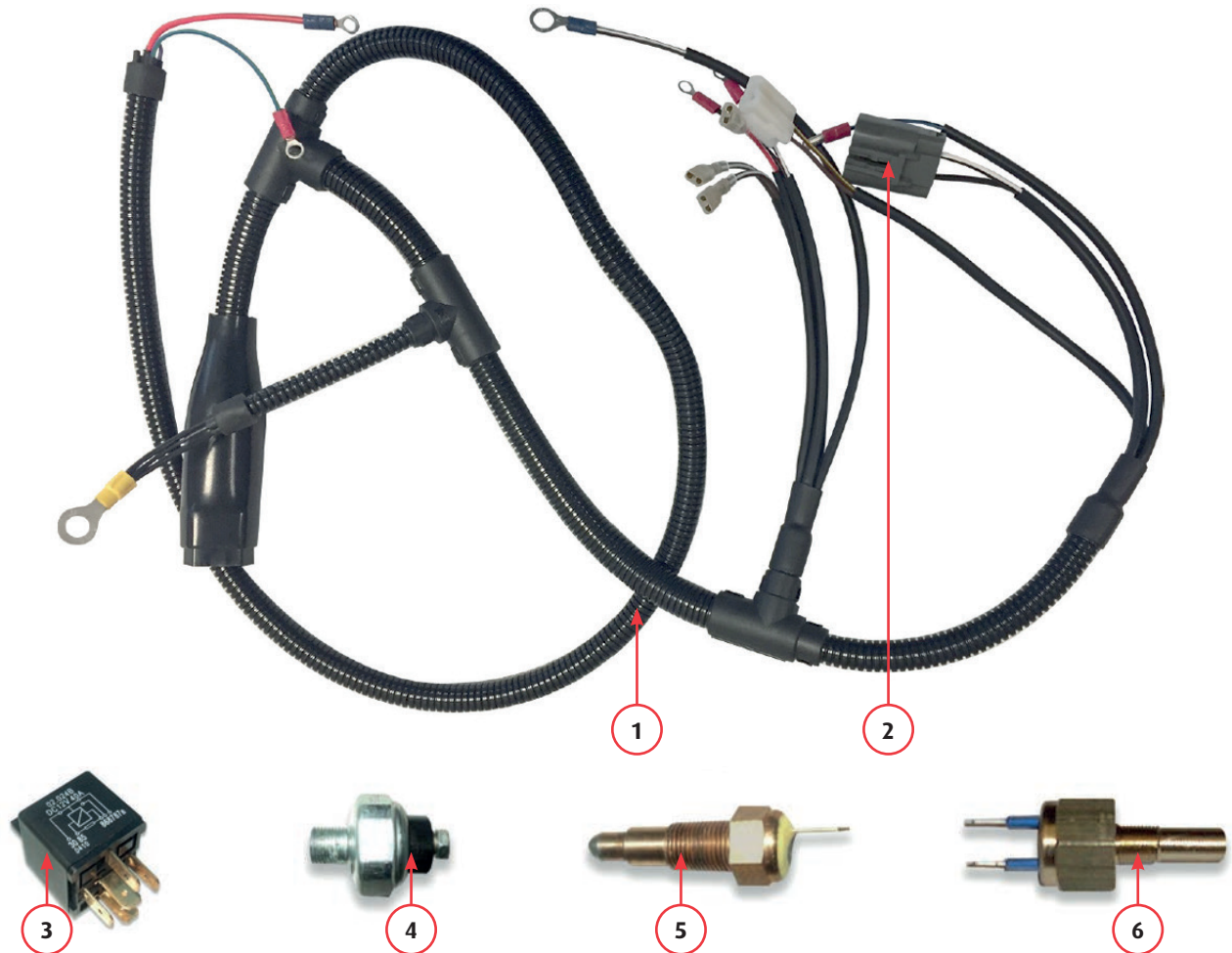

Ref.	Part No.	Description	Qty	Comments
1	200-10468	Beta 70T & 85T engine harness	1	Includes fuse & relay
2	200-00959	40 Amp fuse blade	1	
3	200-87020	Relay 12 Volt 40A (28Ra)	1	
4	600-62670	Oil pressure switch	1	Not C Deluxe & CW panel
5	600-62820	Water temperature switch	1	Not C Deluxe & CW panel
6	200-01133	Water temperature sender switch 95°C 1/8" BSP	1	Not C Deluxe & CW panel
7	212-01480	3/8" BSPT Male x 1/8" BSP Female galvanised adaptor for 200-01133	1	Required if temperature sender is being fitted into 3/8" BSP thread
8	200-04588/01	1 metre extension harness	1	Not shown
9	200-04588/02	2 metre extension harness	1	Not shown
10	200-04588/03	3 metre extension harness	1	Not shown
11	200-04588/04	4 metre extension harness	1	Not shown
12	200-04588/05	5 metre extension harness	1	Not shown
13	200-04588/06	6 metre extension harness	1	Not shown
14	200-04588/08	8 metre extension harness	1	Not shown
15	200-04588/10	10 metre extension harness	1	Not shown
16	200-04588/15	15 metre extension harness	1	Not shown
17	AK/P/7J3/12V3/R00	Relay kit (for extension harnesses)	1	Not shown
18	200-10792/B	Flybridge Y harness	1	Not shown, additionally requires ref no 17

## A Panel – LAMP Type from May 2005



Ref.	Part No.	Description	Qty	Comments
1	AK/2AS/KS01	A panel with 3m loom	1	Complete
2	600-00057	Kubota key switch - suits small key	1	To August 2008
	600-00057/01	Kubota key switch - suits large key		From August 2008
3	600-00058	Kubota keys (small - pair)	1	To August 2008
	600-00058/01	Kubota keys (large - pair)		From August 2008
4	200-00072	Panel stop button	1	
5	200-04657	Red 12V warning lamp & retaining clip	3	
6	200-04656	Green 12V power on lamp & retaining clip	1	
7	N/A	A Panel LAMP type blank	1	Facia only – check for availability
8	200-00639	11 Way plug to suit male type spade	1	Not shown, refer to page 24
9	200-00048	Large shroud for 11 way plug	1	Not shown, refer to page 24
10	200-00047	Male spade for 11 way plug	11	Not shown, refer to page 24
11	200-04655	Alarm board with buzzer	1	Not shown, refer to page 24



Ref.	Part No.	Description	Qty	Comments
1	AK/2ABD/KSO31	AB panel with 3m loom	1	Complete
	AK/2ABD/KSNT01	AB panel with 3m loom		No tachometer
2	200-00072	Panel stop button	1	
3	200-21241	0-3000 rpm tachometer with digital hour counter	1	OCEANLINK From November 2021
	200-02373/03	0-3000 rpm tachometer with digital hour counter		VIEWLINE From January 2010 to November 2021
	200-02373	0-4000 rpm tachometer with hourmeter		VDO From 2002 to January 2010 - No Longer Available
4	600-00057	Kubota key switch - suits small key	1	To August 2008
	600-00057/01	Kubota key switch - suits large key		From August 2008
5	600-00058	Kubota keys (small - pair)	1	To August 2008
	600-00058/01	Kubota keys (large - pair)		From August 2008
6	200-04657	Red 12V warning lamp & retaining clip	4	
7	200-04656	Green 12V power on lamp & retaining clip	1	
8	N/A	AB Panel blank	1	Facia only – check for availability
9	200-00639	11 Way plug to suit male type spade	1	Not shown, refer to page 24
10	200-00048	Large shroud for 11 way plug	1	Not shown, refer to page 24
11	200-00047	Male spade for 11 way plug	11	Not shown, refer to page 24
12	200-04655	Alarm board with buzzer	1	Not shown, refer to page 24
13	200-87020	12V 28Ra 40Amp relay	1	Not shown, refer to page 24



## ABV Panel – LAMP Type from May 2005



Ref.	Part No.	Description	Qty	Comments
1	AK/2ABV/KSOL301	ABV panel with 3m loom	1	Complete
	AK/2ABV/KSNT01	ABV panel with 3m loom		No tachometer
2	600-00057	Kubota key switch - suits small key	1	To July 2008
	600-00057/01	Kubota key switch - suits large key		From July 2008
3	600-00058	Kubota keys (small - pair)	1	To July 2008
	600-00058/01	Kubota keys (large - pair)		From July 2008
4	200-04657	Red 12V warning lamp & retaining clip	3	
5	200-04656	Green 12V power on lamp & retaining clip	1	
6	200-00072	Panel stop button	1	
7	200-21241	0-3000 rpm tachometer with digital hour counter	1	OCEANLINK From June 2021
	200-02373/03	0-3000 rpm tachometer with digital hour counter		VIEWLINE From January 2010 to June 2021
	200-02373/03	0-3000 rpm tachometer & hourmeter		VDO From 2002 to January 2010 - No Longer Available
8	N/A	ABV Panel blank	1	Facia only – check for availability
9	200-00639	11 Way plug to suit male type spade	1	Not shown, refer to page 24
10	200-00048	Large shroud for 11 way plug	1	Not shown, refer to page 24
11	200-00047	Male spade for 11 way plug	11	Not shown, refer to page 24
12	200-04655	Alarm board with buzzer	1	Not shown, refer to page 24
13	200-87020	12V 28Ra 40Amp relay	1	Not shown, refer to page 24



Ref.	Part No.	Description	Qty	Comments
1	AK/2ABVW/KSO31	ABVW panel with 3m loom	1	Complete
	AK/2ABVW/KSNT01	ABVW panel with 3m loom		No tachometer
2	200-00072	Panel stop/start/heat button	3	
3	200-04657	Red 12V warning lamp & retaining clip	3	
4	200-04656	Green 12V power on lamp & retaining clip	1	
5	200-21241	0-3000 rpm tachometer with digital hour counter	1	OCEANLINK From November 2021
	200-02373/03	0-3000 rpm tachometer with digital hour counter		VIEWLINE From January 2010 to November 2021
	200-02373/03	0-3000 rpm tachometer & hourmeter		VDO From 2002 to January 2010 - No Longer Available
6	N/A	ABVW Panel blank	1	Facia only – check for availability
7	200-00639	11 Way plug to suit male type spade	1	Not shown, refer to page 24
8	200-00048	Large shroud for 11 way plug	1	Not shown, refer to page 24
9	200-00047	Male spade for 11 way plug	11	Not shown, refer to page 24
10	200-04655	Alarm board with buzzer	1	Not shown, refer to page 24
11	200-87020	12V 28Ra 40Amp relay	2	Not shown, refer to page 24
12	200-03466	Pektron diode	1	Not shown, refer to page 24
13	200-02618	Diode bridge	1	Not shown, refer to page 24

## Service Kit to Suit ABVW Push Button Control Panels

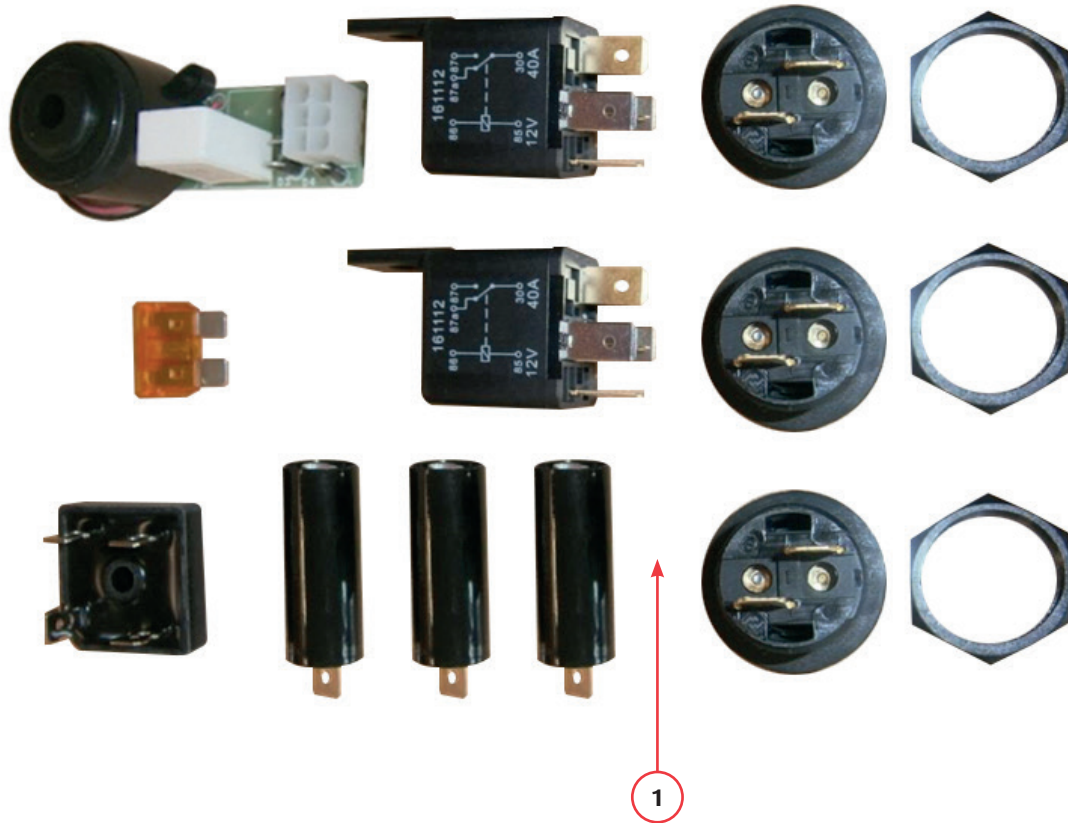

Ref.	Part No.	Description	Qty	Comments
1	AK/2ABVW/RKS01	ABVW panel service kit	1	





Ref.	Part No.	Description	Qty	Comments
1	AK/2BT/KSO31	B Panel with temperature gauge & 3m loom	1	Complete - From May 2005
	AK/2BT/KSNT01	B Panel with temperature gauge & 3m loom		No tachometer - From June 2021
2	600-00057	Kubota key switch - suits small key	1	To July 2008
	600-00057/01	Kubota key switch - suits large key		From July 2008
3	600-00058	Kubota keys (small - pair)	1	To July 2008
	600-00058/01	Kubota keys (large - pair)		From July 2008
4	200-04657	Red 12V warning lamp & retaining clip	3	
5	200-04656	Green 12V power on lamp & retaining clip	1	
6	200-00072	Panel stop button	1	
7	200-21241	0-3000 rpm tachometer with digital hour counter	1	OCEANLINK From July 2021
	200-02373/03	0-3000 rpm tachometer with digital hour counter		VIEWLINE From January 2010 to July 2021
	200-02373/03	0-3000 rpm tachometer & hourmeter		VDO From 2002 to January 2010 - No Longer Available
8	200-96200	Water temperature gauge	1	
9	N/A	B Panel blank	1	Facia only – check for availability
10	200-04655	Alarm board with buzzer	1	Not shown, refer to page 24
11	200-00639	11 Way plug to suit male type spade	1	Not shown, refer to page 24
12	200-00048	Large shroud for 11 way plug	1	Not shown, refer to page 24
13	200-00047	Male spade for 11 way plug	11	Not shown, refer to page 24



## BW Panel – LAMP Type from May 2005



Ref.	Part No.	Description	Qty	Comments
1	AK/2BTW/KSO31	BW Panel with temperature gauge & 3m loom	1	Complete
	AK/2BTW/NT/KS31	BW Panel with temperature gauge & 3m loom		No tachometer
2	200-00072	Panel stop/start/heat button	3	
3	200-04657	Red 12V warning lamp & retaining clip	3	
4	200-04656	Green 12V power on lamp & retaining clip	1	
5	200-21241	0-3000 rpm tachometer with digital hour counter	1	OCEANLINK From December 2021
	200-02373/03	0-3000 rpm tachometer with digital hour counter		VIEWLINE From January 2010 to December 2021
	200-02373/03	0-3000 rpm tachometer & hourmeter		VDO From 2002 to January 2010 - No Longer Available
6	200-96200	Water temperature gauge	1	
7	200-00639	11 Way plug to suit male type spade	1	Not shown, refer to page 24
8	200-00048	Large shroud for 11 way plug	1	Not shown, refer to page 24
9	200-00047	Male spade for 11 way plug	11	Not shown, refer to page 24
10	200-04655	Alarm board with buzzer	1	Not shown, refer to page 24
11	200-87020	12V 28Ra 40Amp relay	2	Not shown, refer to page 24
12	200-03466	Pektron diode	1	Not shown, refer to page 24
13	200-02618	Diode bridge	1	Not shown, refer to page 24
14	AK/2ABVW/RKS01	ABVW panel service kit	1	Not shown, refer to page 15



Ref.	Part No.	Description	Qty	Comments
1	AK/2CD/KSOL31	C Deluxe Panel - Domestic 5 Lamp	1	3m extension harness not included - see ref no 17
	AK/2CD/KSNT01	C Deluxe Panel - Domestic 5 Lamp (No tachometer)		3m extension harness not included - see ref no 17
2	200-00072	Panel stop button	1	
3	600-00057	Kubota key switch - suits small key	1	To July 2008
	600-00057/01	Kubota key switch - suits large key		From July 2008
4	600-00058	Kubota keys (small - pair)	1	To July 2008
	600-00058/01	Kubota keys (large - pair)		From July 2008
5	200-04657	Red 12V warning lamp & retaining clip	4	
6	200-04656	Green 12V power on lamp & retaining clip	1	
7	N/A	C Deluxe panel blank (Domestic 5 Lamp)	1	Facia only – check for availability
8	200-21241	0-3000 rpm tachometer with digital hour counter	1	OCEANLINK From June 2021
	200-02373/03	0-3000 rpm tachometer with digital hour counter		VIEWLINE From January 2010 to June 2021
	200-02373/03	0-3000 rpm tachometer & hourmeter		VDO From 2002 to January 2010 - No Longer Available
9	200-96190	Oil pressure gauge	1	
10	200-96200	Water temperature gauge	1	
11	200-96210	Voltmeter gauge	1	
12	212-04355	1/8" BSP male x female elbow	1	
13	200-94350	Oil pressure sender	1	
14	200-91980	Water temperature sender adaptor	1	Alternatively you can use 1/8" sender
15	200-94360	Water temperature sender	1	200-08248 & adaptor 212-01480
16	200-04588/03	3m extension harness	1	Not shown
17	200-00639	11 Way plug to suit male type spade	1	Not shown, refer to page 24
18	200-00047	Male spade for 11 way plug	11	Not shown, refer to page 24
19	200-04583/5W	Domestic charge load resistor	1	Fits on rear of domestic charge lamp



## CW Panel – 5 LAMP Type from May 2005

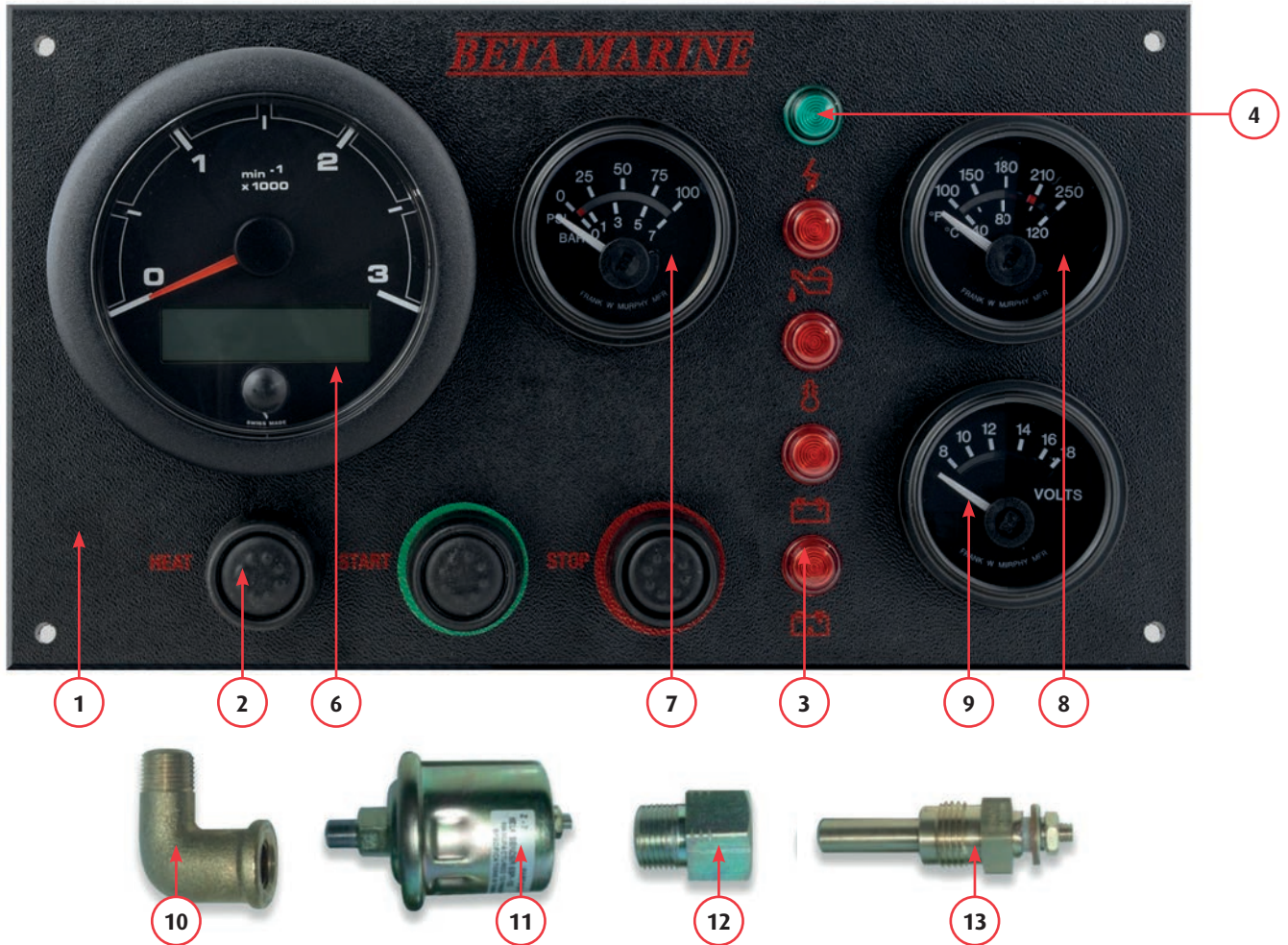

Ref.	Part No.	Description	Qty	Comments
1	AK/2CW/KSOL31	CW Panel – Domestic 5 Lamp	1	3m extension harness not included - see ref no 14
	AK/2CW/KSNT01	CW Panel – Domestic 5 Lamp (No tachometer)		3m extension harness not included - see ref no 14
2	200-00072	Panel stop/start/heat button	3	
3	200-04657	Red 12V warning lamp & retaining clip	3 or 4	
4	200-04656	Green 12V power on lamp & retaining clip	1	
5	200-01293P	CW panel blank - Domestic 5 Lamp	1	Facia only – check for availability
6	200-21241	0-3000 rpm tachometer with digital hour counter	1	OCEANLINK From June 2021
	200-02373/03	0-3000 rpm tachometer with digital hour counter		VIEWLINE From January 2010 to June 2021
	200-02373/03	0-3000 rpm tachometer & hourmeter		VDO From 2002 to January 2010 - No Longer Available
7	200-96190	Oil pressure gauge	1	
8	200-96200	Water temperature gauge	1	
9	200-96210	Voltmeter gauge	1	
10	212-04355	1/8" BSP male x female elbow	1	
11	200-94350	Oil pressure sender	1	
12	200-91980	Water temperature sender adaptor	1	Alternatively you can use 1/8" sender 200-08248 & adaptor 212-01480
13	200-94360	Water temperature sender	1	
14	200-04588/03	3m extension harness	1	Not shown
15	200-00639	11 Way plug to suit male type spade	1	Not shown, refer to page 24
16	200-00047	Male spade for 11 way plug	11	Not shown, refer to page 24
17	200-10135	Diode pack to suit CW panel from December 2015	1	Not shown, refer to page 24



Ref.	Part No.	Description	Qty	Comments
1	AK/P/2D/KS01	D-Digital Panel	1	Requires 3m extension harness and senders - see ref no 4, 5, 6, 7 & 8
2	200-09347	Illuminated rocker switch	1	
3	200-00072	Panel stop/start/heat button	3	
4	200-04588/03	3m extension harness	1	Not shown
5	212-99397	1/8" BSP male x female elbow	1	
6	200-94350	Oil pressure sender	1	
7	200-91980	Water temperature sender adaptor	1	Alternatively you can use 1/8" sender 200-08248 & adaptor 212-01480
8	200-94360	Water temperature sender	1	



## NMEA 2000 Digital Interface - for Installation with Deluxe C/CW Control Panels

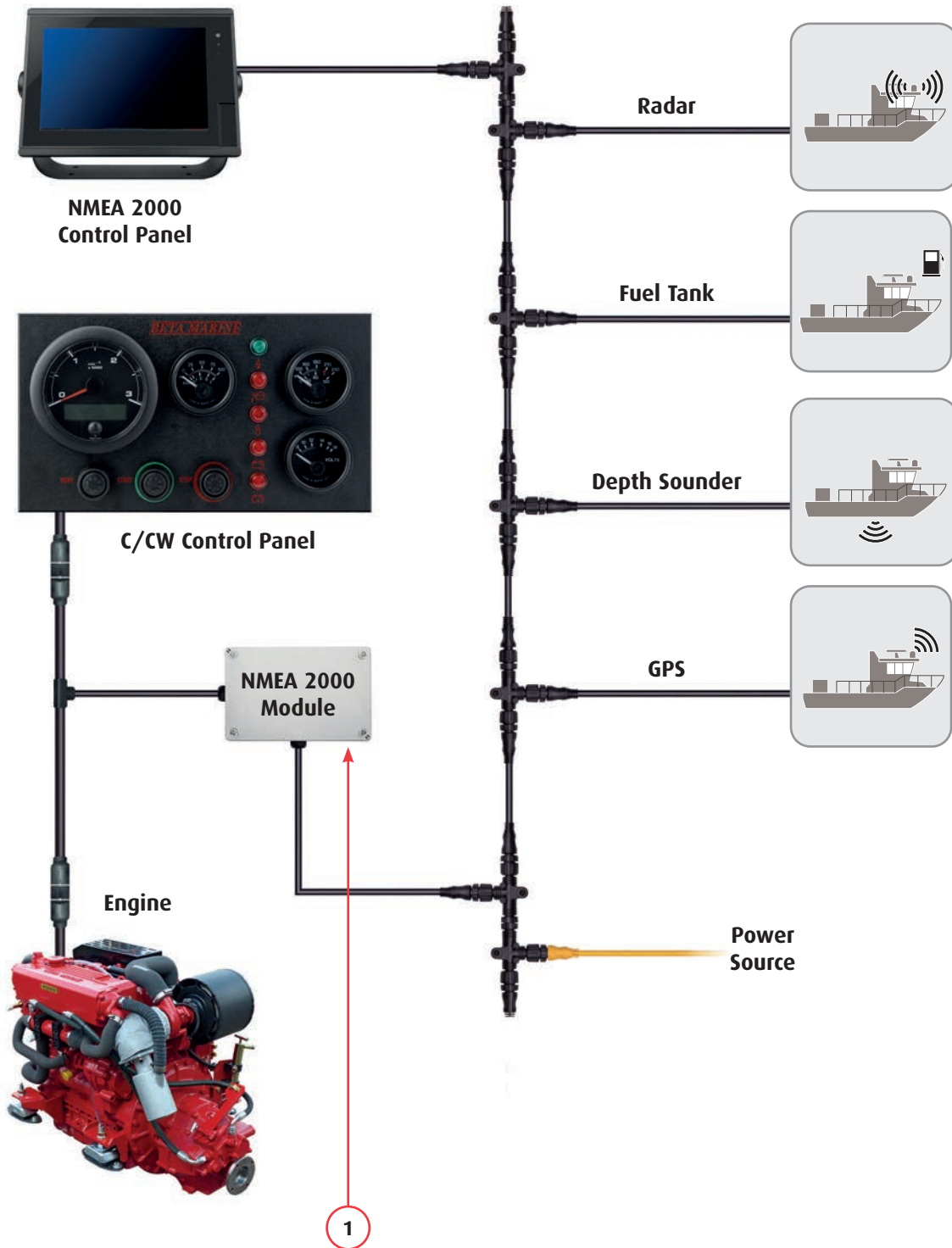

Ref.	Part No.	Description	Qty	Comments
1	AK/P/2D/i01	NMEA 2000 Module for use with C Deluxe & CW panels	1	



Ref.	Part No.	Description	Qty	Comments
1	200-21241	0-3000 rpm tachometer with digital hour counter	1	OCEANLINK From June 2021
	200-02373/03	0-3000 rpm tachometer with digital hour counter	1	VIEWLINE From January 2010 to June 2021
	200-02373/03	0-3000 rpm tachometer & hourmeter	1	VDO From 2002 to January 2010 - No Longer Available
	200-02373	0-4000 rpm tachometer & hourmeter	1	VDO From 2002 to January 2010 - No Longer Available
	200-00054	0-4000 rpm tachometer & hourmeter	1	DATCON To March 2002 - No Longer Available
2	200-08011	Oil pressure gauge	1	VDO VIEWLINE
	200-91380	Oil pressure gauge	1	DATCON
3	200-07981	Water temperature gauge	1	VDO VIEWLINE
	200-91390	Water temperature gauge	1	DATCON
4	200-07980	Voltmeter gauge	1	VDO VIEWLINE
	200-91400	Voltmeter gauge	1	DATCON
5	200-90000	Hourmeter gauge	1	FOZMULA
6	200-01392	Gauge bulb 12V	1	DATCON
7	212-99397	1/8" BSP male x female elbow	1	
8	212-01480	3/8" BSPT M x 1/8" F adaptor tail	1	
9	200-62680	0-5 Bar switch/sender	1	
10	200-01133	Water temperature switch/sender 95°C	1	
11	200-04805	Red tachometer 12v bulb	2	VDO Not shown
12	200-96220	Tachometer bulb 12V	1	DATCON Not shown
13	200-07664	8 Pin gauge connector	1	VIEWLINE Not shown

## Gauge Components



Ref.	Part No.	Description	Qty	Comments
1	200-22729	12 Pin connector	1	For OCEANLINK gauges
2	200-07664	8 Pin connector	1	For VIEWLINE gauges
3	200-08875	Calibration wiring harness	1	For VIEWLINE tachometers
4	200-07664-OL	8 Pin connector	1	To suit OCEANLINE replacement
5	200-10381	OCEANLINE conversion harness	1	To suit VIEWLINE panel
6	200-10091B	Replacement 52mm bezel	1	For VIEWLINE gauges
7	200-10090B	Replacement 85mm bezel	1	For VIEWLINE tachometers

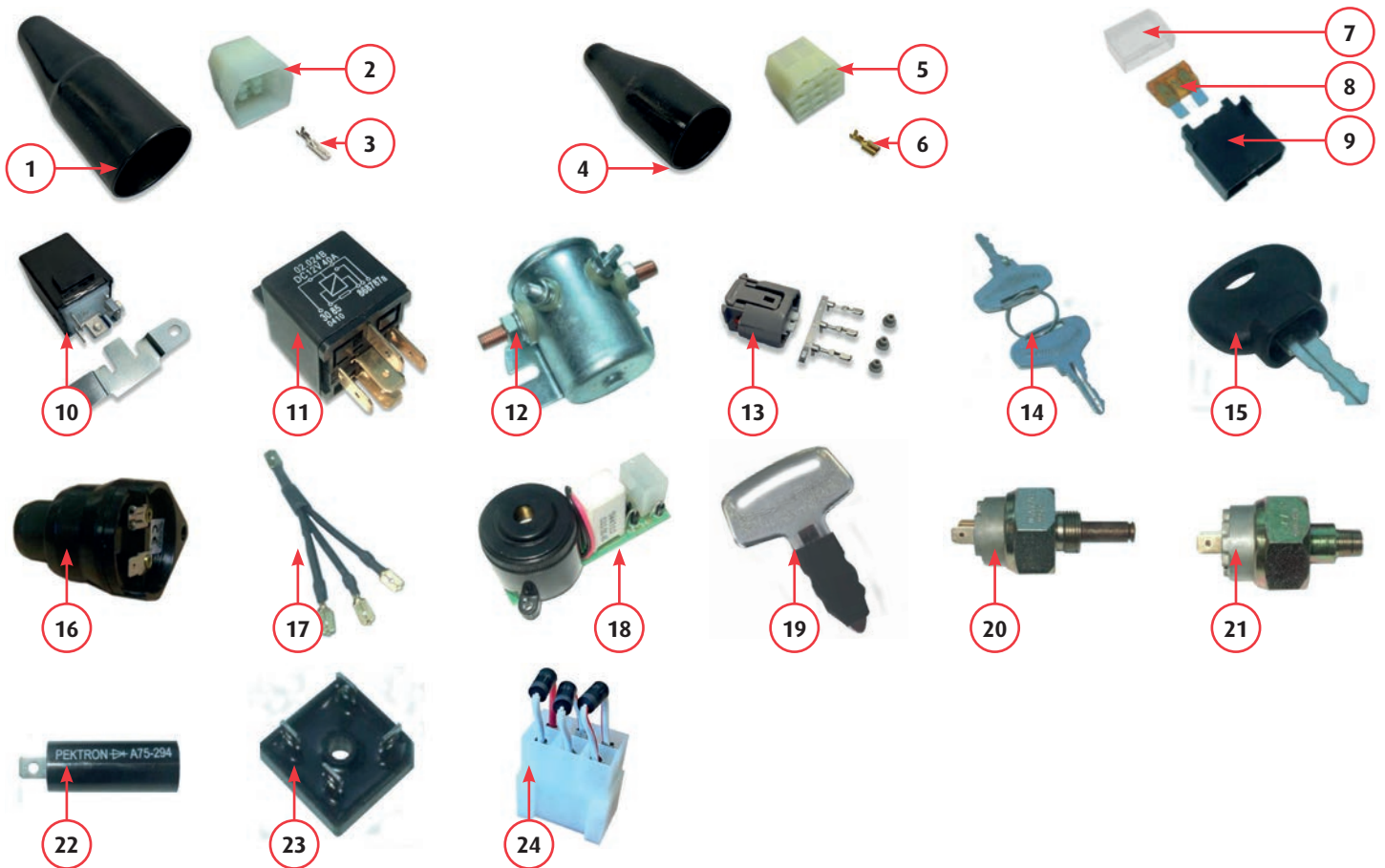

Ref.	Part No.	Description	Qty	Comments
1	200-00048	Large shroud for 11 way plug	1	On panel connection
2	200-00639	11 Way plug to suit male type spade	1	On panel connection
3	200-00047	Male spade for 11 way plug	11	On panel connection
4	200-00638	Small shroud for 11 way socket	1	On engine harness
5	200-00046	11 Way socket to suit female type spade	1	On engine harness
6	200-00181	Female spade for 11 way socket	11	On engine harness
7	200-01426	Plastic clear fuse cover	1	On engine harness
8	200-00959	40 Amp fuse blade	1	On engine harness
9	200-00640	Fuse holder for 40 Amp fuse blade	1	On engine harness
10	200-57640	12V 33Ra 70 Amp relay	1	For extended looms
11	200-87020	12V 28Ra 40 Amp relay	1	On rear of panel
12	200-89950/01	12V heavy duty relay	1	For insulated earth
13	600-02405	Kubota alternator 3 pin coupler	1	For 3 pin Denso alternator
14	600-00058	Kubota keys (small pair)	1	To July 2008
15	200-98965	Murphy keys (pair)	1	To May 2005
16	200-99433	12V buzzer	1	B panel To May 2005
17	200-98980	Panel diode pack	1	ABV To May 2005
18	200-04655	Alarm board with buzzer	1	Standard From May 2005
19	600-00058/01	Kubota keys (large pair)	1	From July 2008
20	200-02069	Water temperature switch 096C 3/8" BSP	1	Generating set standard
21	200-61190	Oil pressure switch 98kPa 1/8" BSP	1	Generating set standard
22	200-03466	Pektron diode	1	Push button panels
23	200-02618	Diode bridge	1	Push button panels
24	200-10135	Diode pack	1	CW panel From December 2015
25	200-04623	14 Core panel cable	/m	Not shown



## Expansion Tank Kits



Ref.	Part No.	Description	Qty	Comments
KIT	AK/SML/EXP/001	Expansion tank kit, complete	1	No Longer Available
1	209-03065	Expansion tank	1	
2	209-03066	Expansion tank lid	1	
3	202-21375	Expansion tank mounting bracket	1	No Longer Available
4	202-21375	Expansion tank holding band	1	No Longer Available
5	212-07011	Hose cap blanking bung	1	
6	212-07009	No 22 Stainless steel hose clip	1	
7	218-99247	3/4" Bore water hose	1m	
8	212-98464	Stainless steel hose clip 22-30mm	1	
9	212-99233	3/8" BSPT 5/8" hose tail	1	

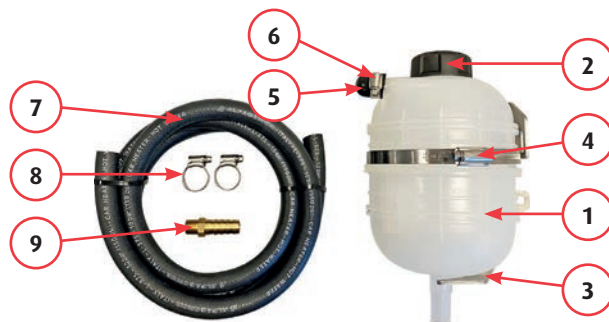

Ref.	Part No.	Description	Qty	Comments
KIT	AK/SML/EXP/002	Expansion tank kit, complete	1	
1	209-03065	Expansion tank	1	
2	209-03066	Expansion tank lid	1	
3	202-21375	Expansion tank mounting bracket	1	
4	262-04015	Stainless steel hose clip 120-140mm	1	
5	212-07011	Hose cap blanking bung	1	
6	212-06818	Stainless steel hose clip 13-20mm	1	
7	218-99247	3/4" Bore water hose	1m	
8	212-98464	Stainless steel hose clip 22-30mm	1	
9	210-03297	3/8" BSPT x 3/4" hose tail	1	

- The sacrificial zinc anode should be replaced every year. This can be more frequent depending on the environment the set is in. The anode is attached to the bolt inserted in the forward end cap of the heat exchanger. Please refer to image 1.
- Unscrew the bolt and replace the complete unit with a new one.
- Check for leaks.
- It is possible for fine sea weed and other debris to get past the inlet filter and into the tube stack. This requires removal of the tube stack for cleaning.
- Drain off coolant into a bucket.
- Unscrew the 8 end cap retaining bolts using a 5mm Hex Key (four each end of the tube stack). Remove the 'O' rings and pull out tube stack. Clean tube stack and end caps.
- Re-assemble using new 'O' rings. Do not over tighten end cap bolts and make sure the tube stack is the right way round. Please refer to image 2.
- Make sure rear end-cap is refitted in the same orientation as it was originally to ensure sea water flows correctly through the tubestack and not straight out of the exhaust. Please refer to image 3.
- Re-fill engine with water/anti-freeze solution and run engine up to temperature to check for leaks.

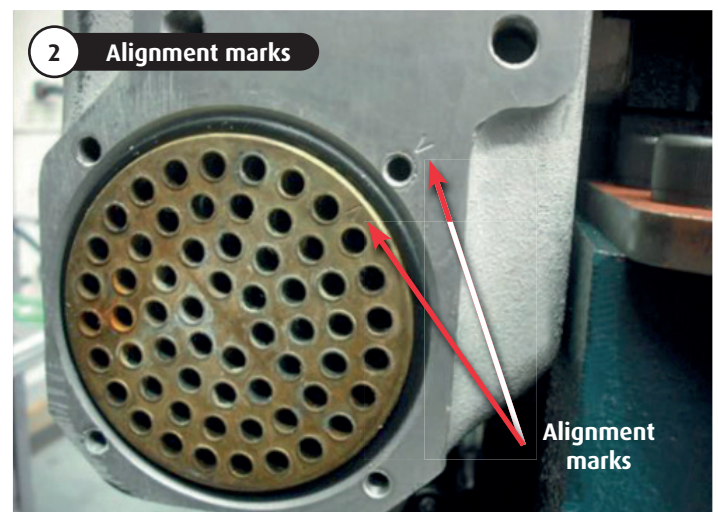
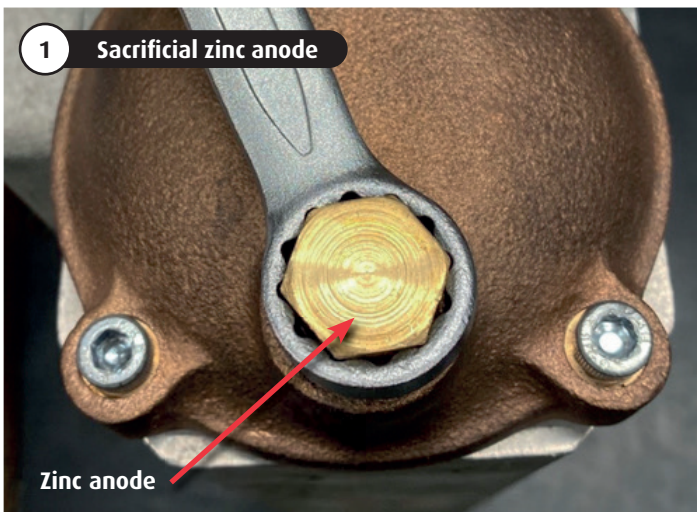

Part No.	Description	Qty
209-00814	V3 heat exchanger 'O' ring	2
209-61840	Sacrificial zinc anode	1



## Replacing Sacrificial Anode & Cleaning Heat Exchanger Tubestack on V3 Series Engines - From 2019

1. The sacrificial zinc anode should be replaced every year. This can be more frequent depending on the environment the set is in. The anode is attached to the bolt inserted in the forward end cap of the heat exchanger. Please refer to image 1.
2. Unscrew the bolt and replace the complete unit with a new one.
3. Check for leaks.
4. It is possible for fine sea weed and other debris to get past the inlet filter and into the tube stack. This requires removal of the tube stack for cleaning.
5. Drain off coolant into a bucket.
6. Unscrew the 8 end cap retaining bolts using a 5mm Hex Key (four each end of the tube stack). Remove the 'O' rings and pull out tube stack. Clean tube stack and end caps.
7. Re-assemble using new 'O' rings. Do not over tighten end cap bolts and make sure the tube stack is the right way round. Please refer to image 2.
8. Make sure rear end-cap is refitted in the same orientation as it was originally to ensure sea water flows correctly through the tubestack and not straight out of the exhaust. Please refer to image 3.
9. Re-fill engine with water/anti-freeze solution and run engine up to temperature to check for leaks.

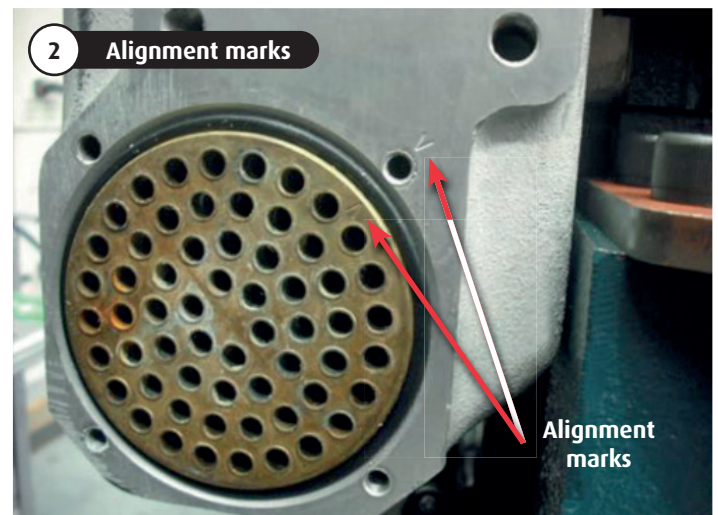
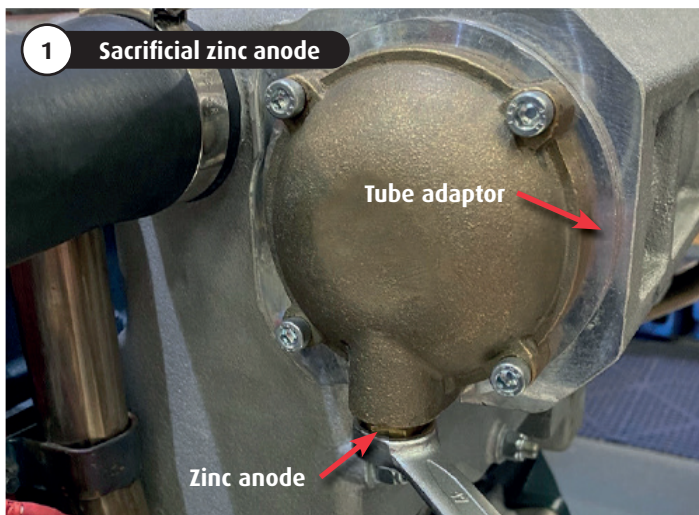

Part No.	Description	Qty
209-21737	Triple 'O' ring kit - for 2019 specification only	1
209-61840	Sacrificial zinc anode	1

**Note:** 2019 Specification heat exchanger manifolds can be identified by the use of an aluminum tube adaptor.

Located on the **forward end** for the Beta 75, 85T, 90, 90T, 105T & 115T. Located on the **aft end** for the Beta 70T.

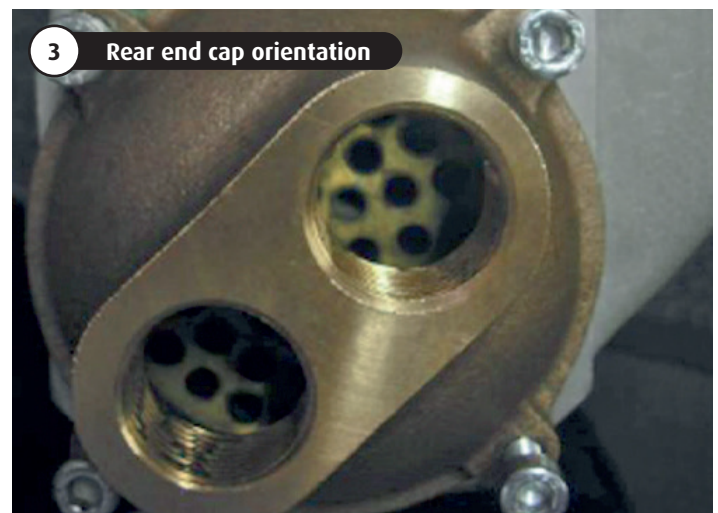



1. Remove 3/8" BSP bung from front of engine below thermostat housing.
2. Fit 3/8" BSP water tap and then the 5/8" hose connector.
3. Remove 3/8" BSP bung from starboard side, under heat exchange manifold.
4. Fit 3/8" BSP Male x Female elbow.
5. Fit water tap and 3/8" BSP x 5/8" hose connector.

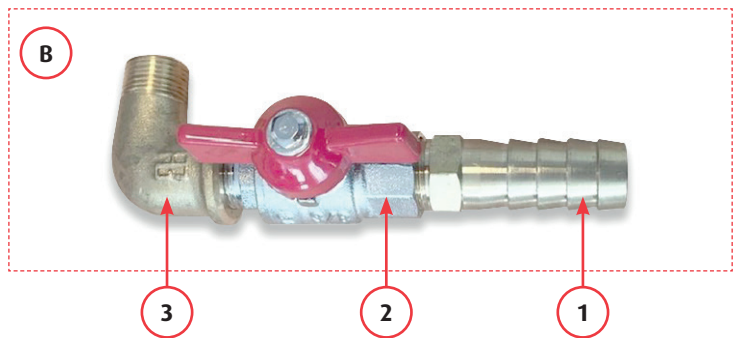
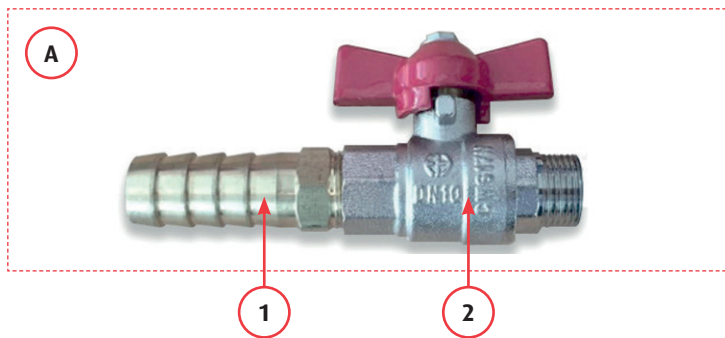
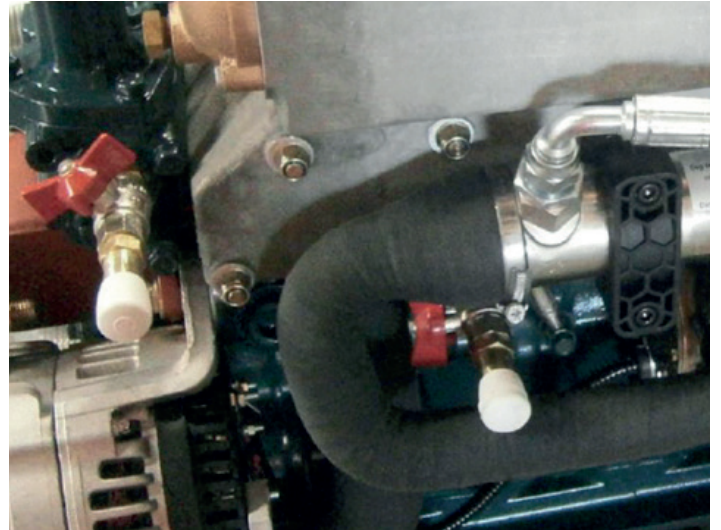

Ref.	Part No.	Description	Qty	Comments
Kit	AK/Beta 85T/CAL/001	Calorifier kit and sub components	1	Includes parts A & B
1	212-99233	5/8" hose connector	1 or 2	
2	210-94530	Water tap	1 or 2	
3	212-99237	3/8" BSP male x female elbow	1	

**Note:** All fittings to be sealed with PTFE tape or pipe sealant to prevent water leaks when engine is at operating temperature and pressure.

## Installation Kits



Ref.	Part No.	Description	Qty	Comments
1	AK/MID/HE/6e/001	Water Inlet Kit - 1 1/4" ID	1	
2	AK/B75/HE/6B/001	Water cooled exhaust kit 60mm	1	V3 non turbo
	AK/B115/HE/6B/001	Water cooled exhaust kit 90mm		V3 turbocharged
3	AK/B75/HE/6C/001	Plastic waterlock kit 60mm	1	V3 non turbo - including 4x hose clips
	AK/B115/HE/6C/001	Plastic waterlock kit 90mm		V3 turbocharged - including 4x hose clips
4	212-00466	Anti-Siphon kit with vent	1	
5	AK/SML/6g/001	Flexible fuel pipes 24" OAL ISO7840	1	
	AK/SML/6k/001	Fuel delivery kit		
6	AK/SML/6k/001	Fuel leak off kit	1	
	AK/SML/6l/H01	Fuel/water separator kit		1
AK/SML/6l/001	Keel cooled 8mm compression			
8	AK/6H/HE/KS01	Electric fuel lift kit 12v	1	Supplied with connections for both heat exchanger and keel cooled engines
9	AK/MID/3h/001	Remote oil filter kit	1	Beta 75, 90, 90T, 105T & 115T
	AK/B70/3h/001			Beta 70T
	AK/B85/3h/001			Beta 85T
10	AK/SML/5a/002	Single lever control	1	
11	212-96070/01	Single lever control cables 3m	1	
12	200-96160/V3/1.5	Battery leads 1.5m, 35mm (x1 black & x1 red)	1	All V3 engines

## Heat Exchanger Cooled

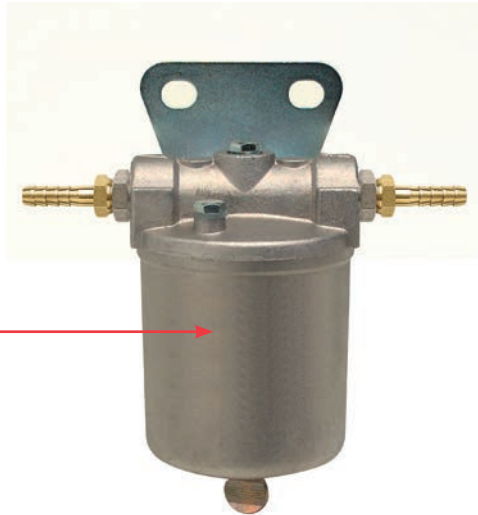

## Keel Cooled

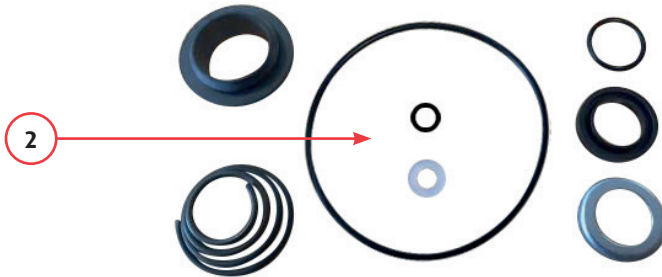
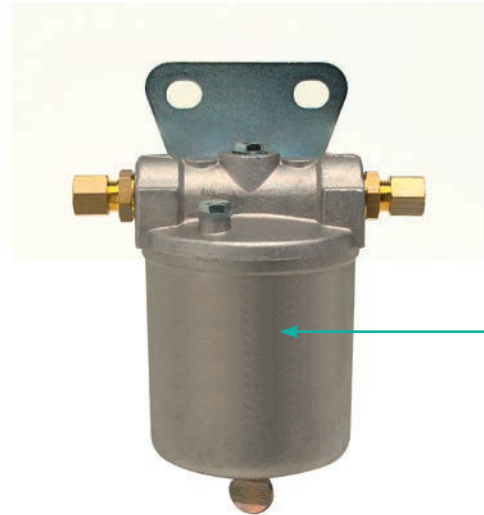

Ref.	Part No.	Description	Qty	Comments
1	AK/SML/6l/H01	Fuel/water separator - heat exchanger cooled	1	8mm hose tails
	AK/SML/6l/001	Fuel/water separator - keel cooled		8mm compression
2	212-02632	Seal kit for separator	1	
3	212-02631	Filter for separator	1	



# ***BETA MARINE***

Notes...

